

Proudly Distributed By:



Tel +44 (0) 161 871 7450
www.instruments4engineers.com

Catalogue



Measure up



About the CHAUVIN ARNOUX GROUP

Instruments 4 Engineers Ltd are proud to be authorised distributors for Chauvin Arnoux in the UK & Ireland. They were founded in 1893 and have spent

centuries since then developing expertise in the design, manufacture and marketing of measuring instruments for professionals.

From handheld instrumentation to fixed electrical equipment and energy performance systems, and from control of the entire thermal process chain to industrial metrology, the **CHAUVIN ARNOUX** Group's offering meets every customer requirement across all the sectors (self-employed electricians, industry, government bodies, etc.).

"CHAUVIN ARNOUX is a major player in the measurement market in France and internationally."

Your partner:

- energy performance
- regulatory testing
- environmental measurements
- installation supervision and sizing.

A Few Figures

- 10 subsidiaries worldwide
- 900 employees
- 6 production sites
- 6 R&D departments worldwide
- 11% of revenues invested in R&D
- Turnover of 100 million euros



Made in France
The French family company Chauvin Arnoux designs and manufactures 80 % of its products in the R&D Centres and production sites owned by the Group. Its three sites in Normandy and its site at Meyzieu, near Lyon, manufacture printed circuit boards, mechanical parts and temperature sensors, while also handling the assembly of measuring instruments for all the Group's brands.

**4 expert measurement
companies in one Group**



Portable test and measurement instrumentation



Metering, measurement and energy performance



Temperatures in industrial processes



Metrology and regulatory testing

Contents

Applications

- Industrial and tertiary applications 4
- Housing applications 6

Testers and Multimeters

- Digital multimeter clamps 8
- Two-pole Voltage Absence Testers (VATs) 10
- Digital multimeters 11
- Portable oscilloscopes 14

Electrical Testing and Safety

- Assessing the safety of installations 16
- Electrical installation testers 17
- Insulation testers 18
- Earth and resistivity testers 21
- Earth and resistivity testers with adapter
for pylon earth measurements 22
- Earth and resistivity kit 22
- Earth clamps and loop testers 23
- Locate hidden cables 23
- Micro-ohmmeters 24
- Single-phase ratiometers 24

Power, Energy and Disturbances

- Symptoms of disturbances on an electrical network 25
- The standards 25
- Power analysers for three-phase electrical networks 26
- Power and energy loggers 29

Environmental Measurements

- No-contact thermometers 30
- Light meters 30
- Tachometers and accessories 30
- Indoor air quality 31

Current Measurements

- AC and AC/DC current measurements 32
- Oscilloscope measurements 33
- Ammeters with flexible sensors 34
- Flexible current sensors 35

Test and Measurement Accessories

- Measurement leads 36
- Protection and transport accessories 38

- Index 39

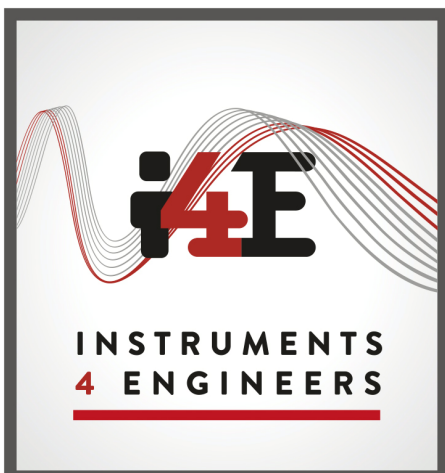

Industrial or Tertiary Applications

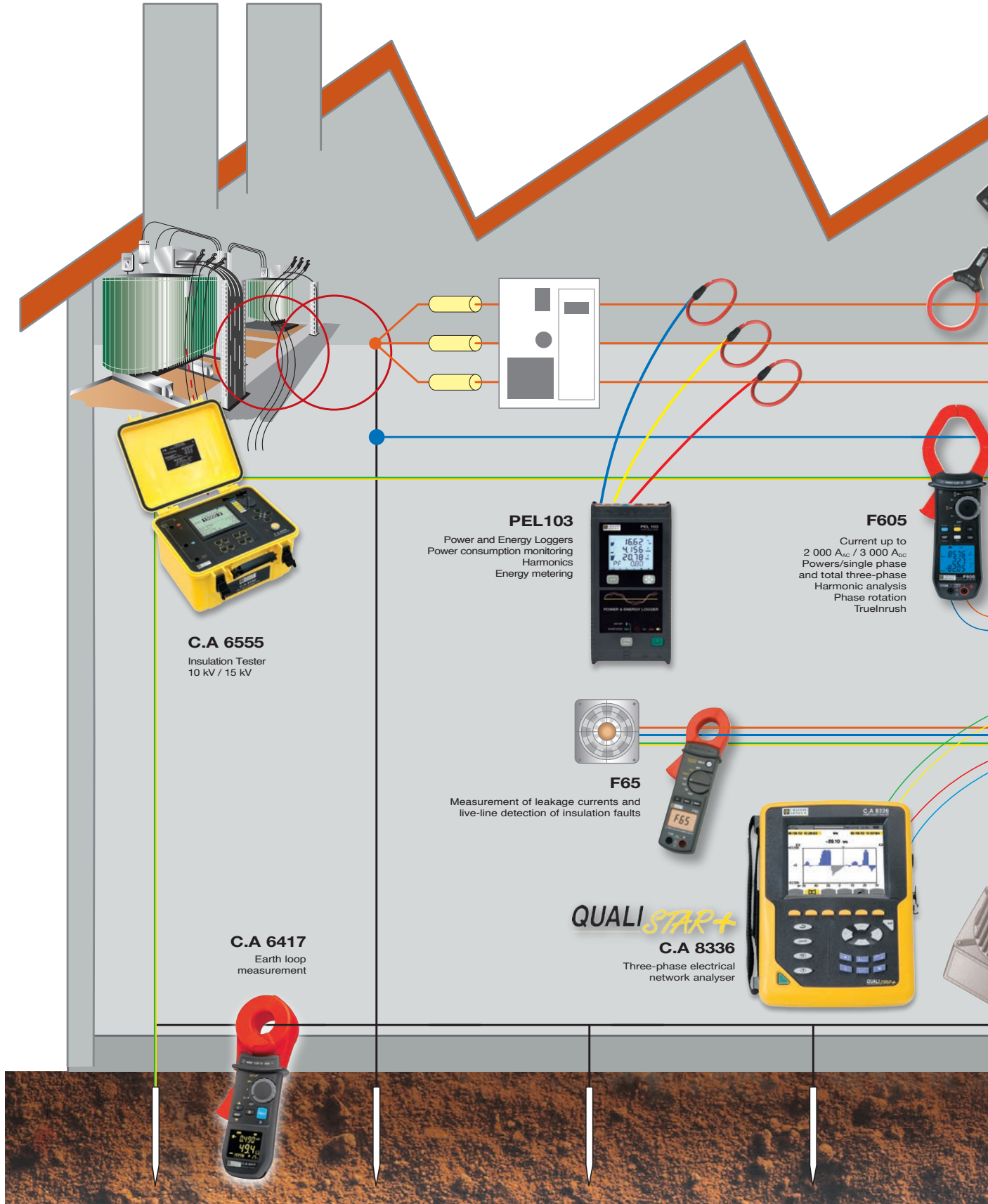

C.A. 6555
Insulation Tester
10 kV / 15 kV

PEL103
Power and Energy Loggers
Power consumption monitoring
Harmonics
Energy metering

F605
Current up to
2 000 A_{ac} / 3 000 A_{ac}
Powers/single phase
and total three-phase
Harmonic analysis
Phase rotation
TrueInrush

F65
Measurement of leakage currents and
live-line detection of insulation faults

C.A. 6417
Earth loop
measurement

QUALI STAR+
C.A. 8336
Three-phase electrical
network analyser

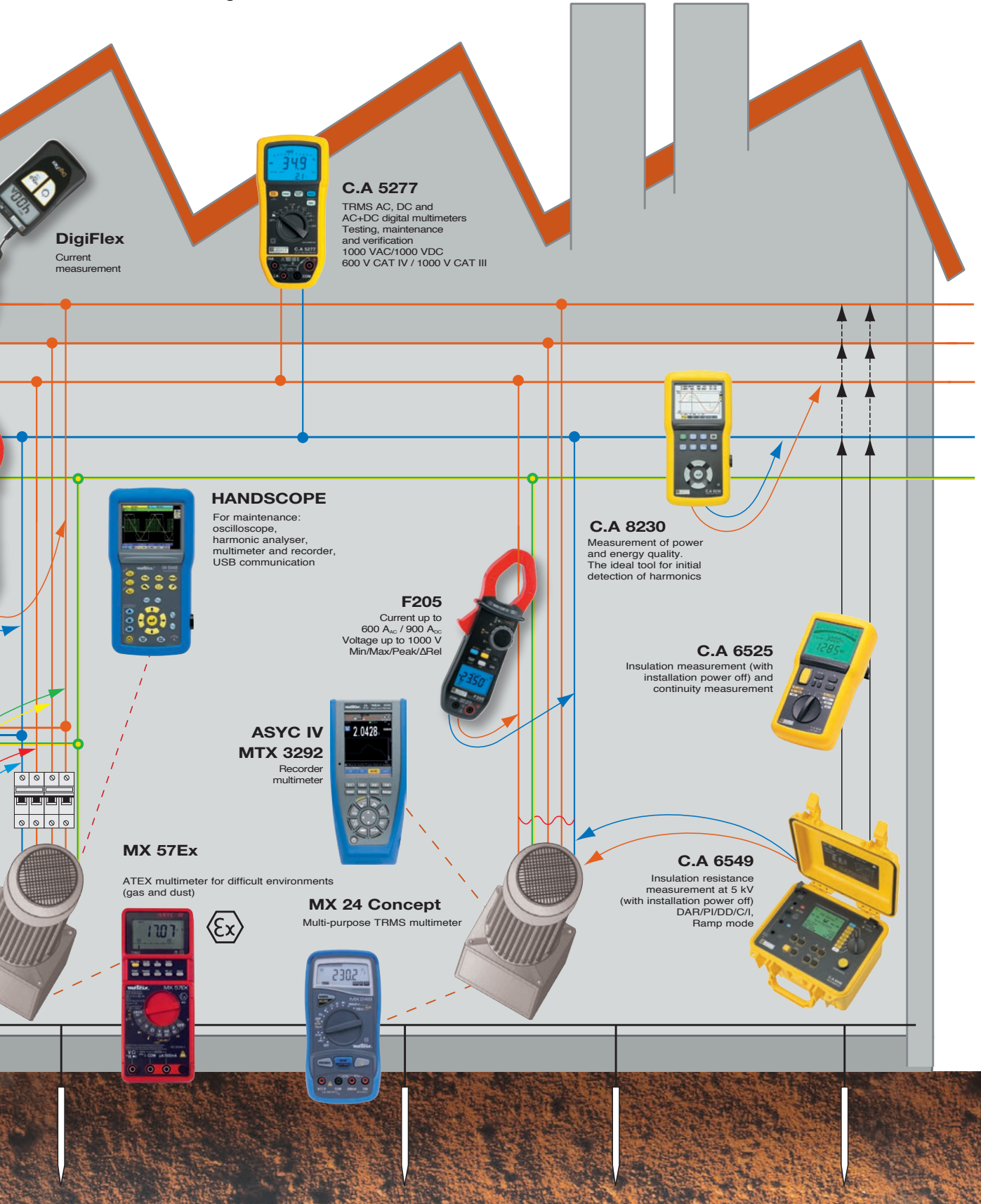

DigiFlex
Current measurement

C.A 5277
TRMS AC, DC and AC+DC digital multimeters
Testing, maintenance and verification
1000 VAC/1000 VDC
600 V CAT IV / 1000 V CAT III

HANDSCOPE
For maintenance: oscilloscope, harmonic analyser, multimeter and recorder, USB communication

F205
Current up to 600 A_{ac} / 900 A_{dc}
Voltage up to 1000 V
Min/Max/Peak/ΔRel

C.A 8230
Measurement of power and energy quality.
The ideal tool for initial detection of harmonics

C.A 6525
Insulation measurement (with installation power off) and continuity measurement

**ASYC IV
MTX 3292**
Recorder multimeter

MX 57Ex
ATEX multimeter for difficult environments (gas and dust)

MX 24 Concept
Multi-purpose TRMS multimeter

C.A 6549
Insulation resistance measurement at 5 kV (with installation power off)
DAR/PI/DD/C/I, Ramp mode



Housing applications

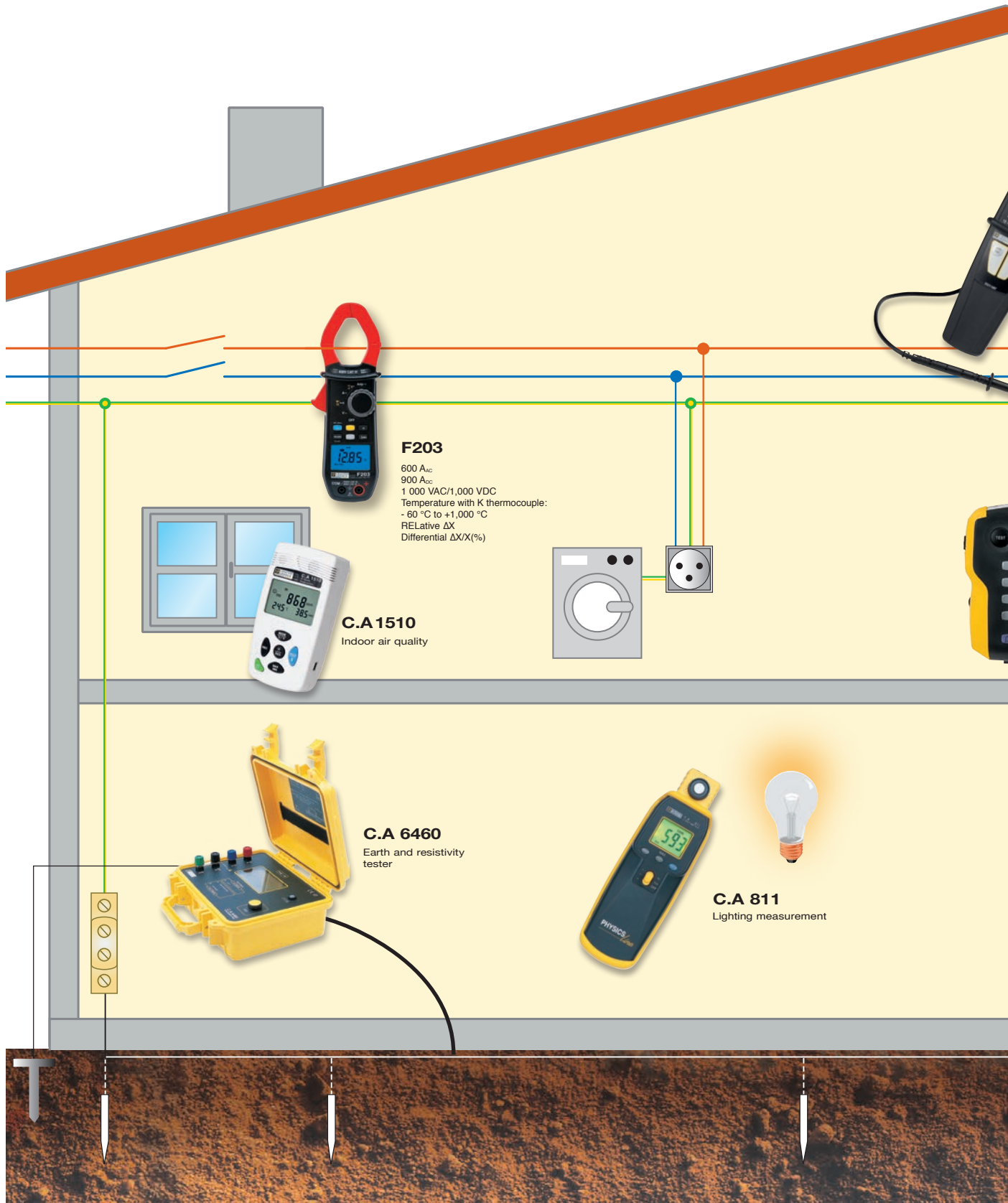



C.A 760N
Two-pole
Voltage
Absence
Tester



C.A 6116N
Electrical installation testing



F403
1,000 A_{AC}
1,500 A_{DC}
1,000 V_{AC/DC}
Single-phase and total
three-phase power values
Frequency analysis
RELative ΔX
Differential $\Delta X/X(\%)$



C.A 6523
Insulation and continuity
measurement

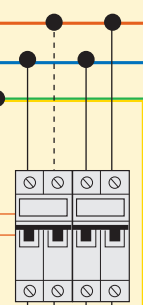

MX 22
Continuity, voltage,
current and Min/Max



C.A 871
Checking of thermal
diffusion in a room

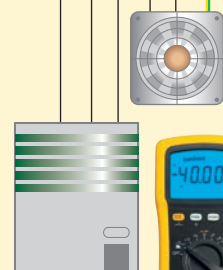

C.A 5275
Digital multimeter
TRMS, AC, DC, AC +DC

Testers and Multimeters

Digital multimeter clamps

3 series of clamps for 3 measurement ranges:
discover our range and choose your clamp!

F200
600 A_{AC} / 900 A_{DC}

F400
1 000 A_{AC} / 1 500 A_{DC}

F600
2 000 A_{AC} / 3 000 A_{DC}

Voltage up to 1,000 V + Resistance, audible continuity + **TrueInRush**

F201 / F401 / F601

AC applications

Everything you need for installations and equipment powered by the mains supply

F203 / F403 / F603

AC or DC applications

DC current
Temperature
Adapter function
 Δ REL

F205 / F405 / F605

Mixed AC+DC applications + testing and maintenance

Power
THD
 Δ REL
Min/Max/Peak
Phase rotation

F407 / F607

Mixed AC+DC applications + analysis and verification

Power
Harmonics
Ripple
Recording
PC software



The Adapter function

can be used to extend the instrument's capabilities through the use of measurement probes (light meter, I/R temperature, tachometer, etc.) with voltage output (AC or DC). A clever system then allows users to directly read the quantity measured.

Phase rotation

For determining the phase order, the use of a "2-wire" microprocessor-controlled measurement system removes the constraints and faults encountered with instruments based on resistive or capacitive technologies when using protective accessories (gloves, mats, etc.) or isolating transformers.

Ripple

Ripple is a parameter used to quantify the quality of the smoothing when currents are rectified and then smoothed. The lower the ripple, the greater the effectiveness of the smoothing. In the case of a switching power supply, the voltage supplied includes residual ripple, particularly at high frequencies. This ripple is harmful for electronic equipment and must therefore be kept to a minimum.

F400 Series

Low and medium-power LV applications

- ▢ 1,000 AAC (or AC+DC) / 1,400 ADC
- ▢ Clamping diameter 48 mm
- ▢ TRMS acquisition
- ▢ TrueInRush function

F600 Series

High-power LV applications

- ▢ 2,000 AAC (or AC+DC) / 3,000 ADC
- ▢ Clamping diameter 60 mm
- ▢ TRMS acquisition
- ▢ TrueInRush function



TrueInRush

1000 V CAT IV



	F201	F203	F205	F401	F403	F405	F407	F601	F603	F605	F607	
Reference	P01120921	P01120923	P01120925	P01120941	P01120943	P01120945	P01120947	P01120961	P01120963	P01120965	P01120967	
Specifications												
Clamping diameter	Ø 34 mm			Ø 48 mm				Ø 60 mm				
Display	LCD		Backlit LCD		Backlit LCD			Backlit LCD				
Resolution	6,000 counts			10,000 counts				10,000 counts				
Number of values displayed	1			1		3		1		3		
Type of acquisition	TRMS [AC]	TRMS [AC]/DC	TRMS [AC, AC+DC]/DC	TRMS [AC]	TRMS [AC]/DC	TRMS [AC, AC+DC]/DC		TRMS [AC]	TRMS [AC]/DC	TRMS [AC, AC+DC]/DC		
Autorange function	Yes			Yes				Yes				
Automatic AC/DC detection	Yes			Yes				-	Yes			
AAC	0.15 to 600 A (900 A peak)			1,000 A				2,000 A (3,000 A peak)				
ADC	0.15 to 900 A peak			1,500 A peak				3,000 A				
AAC+DC	0.15 to 600 A (900 A peak)		1,000 A (1,500 A peak)		1,000 A (1,500 A peak)		2,000 A (3,000 A peak)					
Best accuracy	1 % R + 3 counts			1 % R + 3 counts				1 % R + 3 counts				
VAC	0.15 to 1,000 A (1,400 A peak)			1,000 V				1,000 V				
VDC	0.15 to 1,400 V			1,400 V				1,400 V				
VAC+DC	0.15 to 1,000 V (1,400 V peak)		1,000 A (1,400 A peak)		1,000 A (1,400 A peak)		1,000 A (1,400 A peak)					
Best accuracy	1% R + 3 cts			1 % R + 3 counts				1 % R + 3 counts				
Frequency of V / I				Yes / -				Yes / Yes				
Resistance	60 kΩ			100 kΩ				100 kΩ				
Audible continuity	Adjustable from 1 Ω to 599 Ω			Adjustable from 1 Ω to 999 Ω				Adjustable from 1 Ω to 999 Ω				
Diode test (semi-conductor junction)	Yes			Yes				Yes				
Adapter	Yes			Yes				Yes				
Single-phase and total three-phase power values	Yes			Yes				Yes				
temperature (K type) active (W) reactive (VAR) apparent (VA) FP / DPF	°C: -60.0 to +1,000.0 °C / °F: -76.0 to +1,832 °F			°C: -60.0 to +1,000.0 °C / °F: -76.0 to +1,832 °F				°C: -60.0 to 1,000.0 °C / °F: -76.0 to +1,832 °F				
	Yes		Yes		Yes		Yes		Yes		Yes	
	Yes		Yes		Yes		Yes		Yes		Yes	
	Yes		Yes		Yes		Yes		Yes		Yes	
	Yes / No		Yes / No		Yes / -		Yes / Yes		Yes / -		Yes / Yes	
Harmonic analysis THD, / THD,	Yes / Yes			Yes / Yes				Yes / Yes				
Frequency analysis	No			No				25th order		25th order		
Phase rotation (2-wire method)	Yes			Yes				Yes				
Functions												
Overcurrent measurement	Yes			Yes				Yes				
Motor Inrush	Yes			Yes				Yes				
Load evolution (TrueInrush)	Yes			Yes				Yes				
Hold	Yes			Yes				Yes				
Min / MAX	Yes			Yes				Yes				
Peak+ / Peak-	Yes			Oui				Yes				
RELative ΔX Differential ΔX / X(%)	Yes		Yes		Yes		Yes		Yes		Yes	
Auto Power Off	Yes			Yes				Yes				
Data recording								Yes		Yes		
Communication interface								Bluetooth		Bluetooth		
Electrical safety according to IEC 61010	600V CAT IV			1,000 V CAT IV - 1,000 V CAT III				1,000 V CAT IV - 1,000 V CAT III				
Power supply	1 x 9 V LF22			4 x 1.5 V AA				4 x 1.5 V AA				
Dimensions / Weight	78 x 222 x 42 mm / 340 g			92 x 272 x 41 mm / 600 g				111 x 296 x 41 mm / 640 g				
Warranty	3 years											

Testers and Multimeters

Voltage Absence Testers (VATs)

> C.A 740N & C.A 760N

- Comply with Edition 2 of the IEC 61243-3 standard
- Fulfil the requirements of the EN 50110-1 standard



Specifications	C.A 740N	C.A 760N
Voltage Absence Tester		
Voltage	12 V _{AC} ≤ U ≤ 690 V _{AC} 12 V _{DC} ≤ U ≤ 750 V _{DC}	
Frequency	DC, 16 2/3 à 800 Hz	
Impedance	> 300 kΩ	> 400 kΩ
Max. peak current	3,5 mA RMS	
Polarity indication	Oui	
Redundant dangerous voltage indication	The red ELV (Extra-Low Voltage) LED indicates that the voltage is higher than the SELV (Safety Extra-Low Voltage) and the higher the voltage present, the faster it flashes	
Phase / Neutral identification	Above 50 V (45 – 65 Hz) / Above 150 V (16 2/3 – 45 Hz)	
Continuity with buzzer		
Trigger threshold	100 Ω typical (150 Ω max.)	
Extended continuity test		2 kΩ, 60 kΩ, 300 kΩ
Test current	≤ 1 mA	
Open-circuit voltage	≤ 3.3 V	
Protection	up to 1,000 V	
Phase rotation	No	2-wire method
Ph/Ph voltage	—	50 V ≤ U ≤ 690 V _{AC} (45 - 400 Hz)
Buzzer	Intermittent beep for voltage detection / Continuous beep for continuity	
Standards and electrical safety	CEI 61010 600 V CAT IV	
Enclosure protection	Casing: IP65 – Test probes (option): IP2X	
Climatic conditions	Operation from -15 °C to +45 °C / 20 to 95% RH	
Power supply	2 x 1.5 V batteries (AAA or LR3)	
Battery life	7,500 x 10s measurements	7,000 x 10s measurements
Dimensions / weight	163 x 64 x 40 mm / 210 g	

State at delivery

1 voltage absence tester delivered in blister pack with 1 black Ø 2 mm test-probe lead with crystal safety cover, 1 red Ø 2 mm test probe with crystal safety cover, 1 wrist strap, 2 x 1.5 V LR03/AAA batteries & 1 operating manual in 5 languages.

IP2X version: delivered with 1 set of IP2X Ø 4 mm test-probe leads 0.85 m long (black) and 0.25 m long (red), 1 wrist strap, 2 x 1.5 V LR03/AAA batteries and 1 operating manual in 5 languages.

References and accessories

C.A 740N.....	P01191741Z
C.A 760N.....	P01191761Z
C.A 740N IP2X.....	P01191741B
C.A 760N IP2X.....	P01191761B
Adapter for 2P+E sockets.....	P01101997Z
Spare red test probe for VAT compliant with IEC 61243-3.....	P01102008Z
Spare black test-probe lead for VAT compliant with IEC 61243-3.....	P01102009Z
Adapter for safety rod.....	P01102034
Crystal safety cover for D2 test probe (x 10).....	P01102033
Set of 2 leads 0.25 m and 0.85 m long with Ø 4 IP2X test probes.....	P01295285Z
Set of 2 leads 1.5 m long with Ø 4 IP2X test probes.....	P01295462Z
Soft case, 200 x 100 x 40 mm.....	P01298065Z
Wrist strap.....	P03100824
Multifix bag, 120 x 20 x 60 mm.....	P01298074

TRMS AC, DC, AC+DC digital multimeters

Category IV for safety,
versatility for use in the field



	C.A 5271	C.A 5273	C.A 5275	C.A 5277
Display	6,000 counts	2 x 6,000 counts with backlighting		
Bargraph	61 + 2 elements	61 + 2 elements, dual mode (full scale/central zero)		
Acquisition	TRMS AC /DC		TRMS AC / DC / AC+DC	
Measurement range	5 measurements / second			
Autorange / Deactivatable	Yes / No	Yes / Yes		
Automatic AC /DC detection	Yes		No	
V_{DC}	Ranges 600 mV / 6V / 60V / 600 V / 1,000 V	60 mV / 600 mV / 6 V / 60 V / 600 V / 1,000 V		Typical accuracy 0.09 % + 2 cts
	Resolution 0.1 mV to 1 V	0.01 mV to 1 V		
V_{AC}	Ranges 600 mV / 6 V / 60 V / 600 V / 1,000 V	60 mV / 600 mV / 6V / 60 V / 600 V / 1,000 V		Resolution 0.01 mV to 1 V
	Resolution 0.1 mV to 1 V	40 Hz to 3 kHz		Bandwidth 40 Hz to 10 kHz
V_{Low AC} (low impedance + low-pass filter)	Ranges 600 mV / 6V / 60V / 600V / 1,000 V	0.1 mV to 1 V		
	Resolution 0.1 mV to 1 V	60 mV / 600 mV / 6V / 60 V / 600 V / 1,000 V		
V_{AC + DC}	Ranges 6 A / 10 A (20 A / 30 s)	0.01 mV to 1 V		
	Resolution 0.001 A to 0.01 A	6,000 μ A / 60mA / 600 mA / 6 A / 10 A (20 A / 30 s)		
A_{DC}	Ranges 6 A / 10 A	1 μ A to 0.01 A		
	Resolution 0.001 A to 0.01 A	ionization current: 0.2 μ A to 20.0 μ A		
A_{AC}	Ranges 6 A / 10 A	6,000 μ A / 60 mA / 600 mA / 6 A / 10 A (20 A / 30 s)		
	Resolution 0.001 A to 0.01 A	1 μ A to 0.01 A		
A_{AC + DC}	Ranges 600 Ω / 6,000 Ω / 60 k Ω / 600 k Ω / 6 M Ω / 60 M Ω	1 μ A to 0.01 A		
	Resolution 0.1 Ω to 0.1 M Ω			
Resistance	0.1 Ω to 0.1 M Ω			
Audible continuity	Yes			
Test diode	Yes			
Hz	Ranges 600 Hz / 6 kHz / 50 kHz	0.1 Hz to 10 Hz		
	Resolution 6 nF / 60 nF / 600 nF / 6 μ F / 60 μ F / 600 μ F / 6 mF / 60 mF	0.001 nF (1pF) to 10 μ F		
Capacity	Ranges -59.6 $^{\circ}$ C to +1,200 $^{\circ}$ C -4 $^{\circ}$ F to +2,192 $^{\circ}$ F	-59.6 $^{\circ}$ C to +1,200 $^{\circ}$ C -4 $^{\circ}$ F to +2,192 $^{\circ}$ F		Resolution 0.1 $^{\circ}$ to 1 $^{\circ}$
T$^{\circ}$	Ranges -59.6 $^{\circ}$ C to +1,200 $^{\circ}$ C -4 $^{\circ}$ F to +2,192 $^{\circ}$ F	0.1 $^{\circ}$ to 1 $^{\circ}$		Resolution 0.1 $^{\circ}$ to 1 $^{\circ}$
Hold	Hold			
Min / MAX (100 ms)	No	Yes		
Peak+ / Peak- (1 ms)	No	Yes		Yes
Differential measurement (X) / Relative (DX/X%)	No	Yes		Yes
Automatic power-off	Yes (deactivatable)			
Power supply	1 x 9 V			
Dimensions / Weight	90 x 190 x 45 / 400 g			

State at delivery

C.A 5270 multimeter delivered with a set of banana leads, a set of test probes, a 9 V battery and a CD containing the operating manual and the start-up guide.

C.A 5271 standard state at delivery

C.A 5273 with additional K thermocouple temperature sensor

C.A 5275 with additional bag and Multifix adapter

C.A 5277 with additional K thermocouple temperature sensor, bag and Multifix adapter

To order

C.A 5271 TRMS AC/DC multimeter	P01196771
C.A 5273 TRMS AC/DC multimeter	P01196773
C.A 5275 TRMS AC+DC multimeter	P01196775
C.A 5277 TRMS AC+DC multimeter	P01196777

Universal Testing and Measurement

Digital multimeters

The MX 57Ex is certified ATEX & IECEx and can be used in both explosive and non-explosive environments.



This IP 67 instrument fulfils the requirements of the directives concerning difficult environments. It is totally protected against:

- dust
- the effects of temporary immersion



	MX 22	MX 24B	MX 57Ex
Reference	MX0022-Z	MX0024-G	MX0057CX
Display	4,000 counts	5,000 counts	50,000 counts
Bargraph	Yes		Analogue, 34 segments, 20 meas./s
Type of measurement	AVG	TRMS	TRMS AC & AC+DC
DC voltage	600 V	1,000 V	5 calibres from 500 mV to 600 V
AC voltage	600 V	750 V	5 calibres from 500 mV to 600 V
Bandwidth	500 Hz	1 kHz	50 kHz
AC/DC current	400 μ A, 4-40-400 mA, 4 A, 10 A	500 mA/10 A	500 μ A, 5 mA, 50 mA and 500 mA
Frequency	4 MHz	500 kHz	Range from 0.62 Hz to 500 kHz
other measurements			
Resistance	40 M Ω	50 M Ω	6 ranges from 500 Ω to 50 M Ω
Audible continuity	< 40 Ω	10 to 20 Ω	Detection threshold from 10 Ω to 20 Ω - resp. time 1 ms
Diode test	0 à 4 V	0 to 2 V	from 0 to 2 V
Capacitance	-	50 nF to 50 mF	7 ranges from 50 nF to 50 mF
Temperature	-	-	-200 $^{\circ}$ C to +800 $^{\circ}$ C / Pt100 and Pt1000 probes
Other measurements	Min / Max	Min / Max	Duty cycle - dB function and U2/R resistive power Pulse width - timer Event counting
Protection rating	IP 40		IP 67
Safety	CAT III 600 V		ATEX 94/9/CE directive, EN/IEC 60079-0-EN: IEC 60079-11, EN/IEC 61241-11-EN/IEC 61241-0, EN/IEC 61010-1-600 V CAT III, CE inspection certificate type LCIE 02 ATEX 6005X & additional clauses 01, 02, 03, 04
Dimensions	170 x 80 x 35 mm		189 x 82 x 40 mm
Weight	300 g		400 g
State at delivery	Elastomer sheath, set of 2 safety leads, 9 V battery (installed), verification certificate and operating manual		Carrying case, set of safety test-probe leads, 1 spare intrinsic-safety fuse, operating manual

Accessories

MX 22 and MX 24B

- Sheath > AE0237
- Hard case > AE0190

MX 57Ex

- Sheath > MC0160B
- Handle > MC0159B
- Soft case > AE0193
- Hard case > AE0227



Digital Multimeters ASYC IV range

The 1st multimeters with graphical colour screens!



NEW



Reference	MTX3290	MTX 3291 *	MTX3292	MTX3293
	MTX3290	MTX3291	MTX3292 MTX3292-BT Bluetooth	MTX3293 MTX3293-BT Bluetooth
DC, AC and AC+DC voltages	60 mV to 1,000 V		-40 to +1,200°C	
DC accuracy	0.3%	0.05%	0.03%	0.02%
AC and AC+DC bandwidth	20 kHz	100 kHz	100 kHz	200 kHz
DC, AC and AC+DC current	600 µA to 10 A /20 A (30 s max)*		1,000 µA to 10 A / 20 A (30 s max)	
DC accuracy	0.08%		0.01%	
Frequency	60 Hz to 600 kHz		10 Hz to 5 MHz	
Resistance	600 Ω to 60 MΩ		100 Ω to 100 MΩ	
Audible continuity	600 Ω SIGNAL <30 Ω ±5 Ω < 5V		1000 Ω SIGNAL <20 Ω < 3.5V	
Diode test	3 V with 1 mV		Diode 0 -2.6 V <1 mA + Zener Diode or LED 0-20 V<11 mA	
Capacitance	6 nF to 60 mF		1 nF to 10 mF	
Temperature Pt100/1000	-200°C to 800°C			
Temperature K/J TC	-			
OTHER FUNCTIONS				
Surveillance	Time/date-stamped MAX/MIN /AVG or PEAK ±, on all the main positions		SURV time/date-stamped MAX/MIN /AVG or PEAK ±, on all the main positions	
REL	REL relative value + measured reference value on secondary display*		Relative value REF-delta unit or on 3 displays + main measurement	
PWM filter	4 th -order 300 Hz low-pass filter for measuring on variable speed drives of asynchronous motors			
V-output clamp function for direct reading	Integration of the ratio: 1/1 ,1/10,1/100,1/1000 mV/A		Parameterizable Ax ratio	
Secondary functions or measurements	dBm and VA resistive power, +/- duty cycle, and pulse width*		3 measurements + main measurement	
SPEC	-		Display of measurement tolerance: Smin, Smax	
GRAPH	-		Trends of main measurements <60s + Zoom + Cursor	
Central zero	Selectable or automatic* bargraph for VDC and IDC		Automatic trend bargraph	
Measurement storage	-		1,000	6,500
GENERAL SPECIFICATIONS				
Type of display	LCD with backlighting* and digits 14 mm high Double 60,000* or 6,000-count display		Colour graphical display (70x52) with backlighting on 4 100,000-count displays	
PC interfaces	-	USB optical connector & SX-DMM software	USB optical connector or Bluetooth (option)- SX-DMM software	
Alimentation	4 x AA batteries or Ni-MH batteries		Charger or 4 x AA batteries or Ni-MH batteries	
Safety	Safety as per IEC 61010-1 1,000V-CATIII / 600V CAT IV* OR 600V CAT III / 300V CAT IV – Safety as per IEC 61010-2-033		Safety as per IEC 61010-1 1,000V-CAT III / 600V CAT IV – Safety as per IEC 61010-2-033	
Environment	Storage: -20 °C to +70 °C – Operation: -10 °C to +55 °C		Storage: -20 °C to +70 °C – Operation: 0 °C to +40 °C	
Mechanical specifications	Dimensions (L x W x H): 196x90x47.1 mm – Weight: 570 g			
Warranty	3 years			

State at delivery

- **MTX 3290:** delivered with 4 x 1.5 V alkaline batteries, 1 red straight/straight lead 1.5 m long, 1 black straight/straight lead 1.5 m long, 1 red CAT IV 1 kV test probe, 1 black CAT IV 1 kV test probe, 1 user's manual on CD and 1 start-up guide on paper
- **MTX 3291:** delivered with 4 x 1.5 V alkaline batteries, 1 red straight/straight lead 1.5 m long, 1 black straight/straight lead 1.5 m long, 1 red CAT IV 1 kV test probe, 1 black CAT IV 1 kV test probe, 1 user's manual on CD and 1 start-up guide on paper plus 1 bag, 1 USB cable and 1 user's programming manual SCPI and SX-DMM software
- **MTX 3292 and MTX 3293:** delivered with 1 bag, 4 NI-MH 2400mAh 1.5 V rechargeable batteries, 1 charger, 1 red straight/straight lead 1.5 m long, 1 black straight/straight lead 1.5 m long, 1 red CAT IV 1 kV test probe, 1 black CAT IV 1 kV test probe, 1 optical USB cable + SX-DMM software, 1 user's manual on CD and 1 user's programming manual SCPI, 1 start-up guide on paper

Accessories

- MTX329X graphical colour calibration software > **HX0059B**
- Kit of 4 Ni-MH rechargeable batteries > **HX0051B**
- External charger MTX 328X, MTX 329X (4 batteries included) . > **HX0053B**
- MTX digital DMM transport kit > **HX0052B**
- Graphical colour DMM transport kit > **HX0052C**
- MTX 3290 / 3291 calibration software > **P01196770**



Testers and Multimeters



Portable oscilloscope SCOPIX[®] range

The OX 7202 and OX 7204 offer a bandwidth of 200 MHz, storage on removable SD card and a new TFT screen.
2 versions of the OX 7104 and OX 7042 are specially designed for electrical power applications

	OX 7042	OX 7062	OX 7102	OX 7104	OX 7202	OX 7204
Bandwidth	40 MHz	60 MHz	100 MHz	100 MHz	200 MHz	200 MHz
	Bande passante avec filtres					
Channels	2 isolated channels			4 isolated channels	2 isolated channels	4 isolated channels
IEC 61010 safety	Cat. III – 600 V			Cat. III – 600 V	Cat. III – 600 V	Cat. III – 600 V
Sampling rate per channel	2.5 GS/s in one-shot mode or 100 GS/s for periodic signals					
Transient detection	Glitch capture – minimum duration 2 ns					
Vertical resolution	12 bits, giving a vertical resolution of 0.025 %					
Display modes	Vector, interpolation, persistence (enveloppe), averaging (factors 2 to 64)					
Scaling and physical units	Definition of a factor and the corresponding unit					
Digital oscilloscope						
Input sensitivity	2.5 mV to 200 V/div (156 µV max. with zoom, thanks to the 12-bit resolution)					
Time base	1 ns to 200 s/div, 100 ms to 200 s/div Roll mode					
Memory	Up to 200 curves of 2,500 points (including universal "text" format) – memory depth up to 50 k Mass storage of up to 2 GB on removable SD card					
Reference curves on screen	1 per active channel (1 to 4) / Direct storage by means of dedicated key					
Automatic measurements with marker	19 simultaneous measurements on a curve or deviations in relation to the reference curve – 12-bit resolution					
Triggering	Edge, pulse width, delay, counting, video with line counter, on one of the 16 automatic measurements					
Calculation functions on channels	FFT on 2,048 points, +, -, x, /, and complex function generator					
TRMS multimeter (AC, AC+DC)						
Measurement channels with 200 kHz bandwidth	2 isolated channels			4 isolated channels	2 isolated channels	4 isolated channels
Measurement functions	Voltage, current, frequency, resistance, capacitance, temperature (Pt 100, K thermocouple), Diode test and audible continuity, relative mode, min/max mode					
Graph of measurements with cursors	Duration from 5 minutes to 31 days, data storage in universal "text" format – triggering on thresholds					
Harmonic analyser*						
Multi-channel analysis (2 or 4 depending on model)	61 orders, fundamental frequency from 40 Hz to 450 Hz					
Simultaneous measurements	Total Vrms, THD and selected order (% fundamental, phase, frequency, Vrms)					
12-bit digital recorder*						
Multi-channel recording	Duration 2 s to 31 days, normal mode or capture of 510 faults with pre-trigger - sampling interval from 40 µs					
Recording conditions	On thresholds or window, simultaneous conditions on several channels – recording in memory or on PC hard disk					
Analysis of recordings	Scale and physical units, measurement using cursors, search for faults, zoom, etc.					
Power measurement*						
Measurement functions	Active power on single-phase or three-phase and PF					
Harmonics	Harmonic analysis on apparent power					
General specifications						
Windows-like operator interface	B&W or colour*		Colour			
Simultaneous display of traces	Up to 4 traces + 4 reference curves on the screen / "full screen" trace mode					
PC communication	Isolated RS232*, USB* or 10 Mb Ethernet / Network printers or Centronics / FTP mode to use the PC hard disk for back-up storage / LPD mode for printing on a printer connected to a PC / Web server with real-time display, remote control and automatic measurement					
Printing	Battery life up to 4 hours, fast charging in 2 hours without removing batteries					

* Depending on model or option

References for ordering and state at delivery

OX7042-MSD • OX7042-CSD • OX7062-CSD
OX7102-CSD • OX7202-CSD • OX7204-CSD

• **Oscilloscope in cardboard box with:**

external power supply/battery charger, NiMH battery pack, magnetic stylus, 1/10 Probix HX0030B probe for 2-ch. version and 2 probes for 4-ch. version, Probix HX0031 BNC adapter for 2-ch. version and 2 adapters for 4-ch. version, Probix HX0033 Ø 4 mm banana adapter, set of Ø 4 mm banana leads + test probe, HX0040 crossed-Ethernet cable, HX0084 USB cable, µSD card with minimum capacity of 1 GB and SD-Card adapter, operating and programming manual and LW/LV drivers on CD-Rom.

OX7042P-CSDK • OX7104P-CSDK

• **Same as version -MSD and -CSD plus:**

1/10 Probix HX0030B probe, Probix HX0031 BNC adapter, HX0072 and HX0073 FLEX current probes, 2 HX0071 industrial accessories kits for HX0030B Probix probe, HX0039 straight-Ethernet cable, SX-METRO/P processing software (all software options installed) and carrying case.

OX7104-CSDO • OX7204-CSDO

• **Same as version -MSD and -CSD plus:**

2 x 1/10 Probix HX0030B probes, SX-METRO/P processing software with harmonics, logger and 50 KB options installed, carrying case.



Handheld oscilloscope with isolated channels



	OX 5022	OX 5042
Man-machine interface		
Type of display	3.5" colour TFT LCD screen – Resolution 320x240 – LED backlighting	
Display mode	2,500 real acquisition points on screen	
Display of curves on screen	2 curves + 2 references + memory trace or mathematical calculation	
Commands	Direct adjustments on front panel & on-screen menus via browser (principal & secondary without "hidden menus")	
Integrated interactive help function	11 languages: French, English, German, Spanish, Italian, Swedish, Romanian Rumanian, Russian, Finnish, Polish, Dutch	
Oscilloscope mode / Vertical deflection		
Bandwidth	20 MHz	40 MHz
Bandwidth limiter	1,5 MHz, 5 kHz	
Number of channels	2 totally-isolated channels	
Input impedance	1 M Ω \pm 0.5 %, approx. 17 pF	
Maximum input voltage	600 V CAT III – Derating -20dB per decade from 100 kHz	
Vertical sensitivity	5 mV to 200 V/div	
Horizontal deflection		
Sweep speed	25 ns/div to 200 s/div – Roll Mode from 100 ms to 200 s/div	
Horizontal zoom	Zoom factor: x1, x2, x5	
Triggering		
Mode	Automatic, triggered, one-shot & triggered Roll	
Type	Edge, pulse width (20 ns – 20 s)	
Coupling	AC or DC (depending on the coupling of the triggering channel), HF, LF or noise rejection	
Sensitivity	\leq 1.2 divisions p-p up to 20 MHz	\leq 1.2 divisions p-p up to 40 MHz
Digital memory		
Maximum sampling rate	Automatic, triggered, one-shot & triggered Roll	
Vertical resolution	9 bits	
Memory depth	2,500 points per channel	
User storage	2 MB for storing trace (.trc), text, (.txt), configuration (.cfg) and image files (.bmp)	
GLITCH mode	Duration \geq 20 ns – 1,250 Min/Max pairs	
Display modes	Envelope, Averaging (factors 2 to 64) and XY (vector)	
Other functions		
MATH functions	Channel inversion, addition, subtraction, multiplication and division (adjustable scaling)	
Cursor measurements	2 cursors: V, T, dV, dt simultaneously –4-digit display resolution	
Automatic measurements	18 time or level measurements and phase measurement	
Multimeter mode		
General specifications	2 channels, 8,000-count display + min/max bargraph – Graphic recording of 2,700 measurements (5 min to 1 month)	
Operating modes	Absolute or relative display (absolute, deviation, ref, ref%) – Monitoring (instantaneous, Min, Max, Avg)	
AC, DC and AC+DC voltages	Ranges from 600 mV to 600 VRMS, 800 mV to 800 VDC – accuracy for VDC 1 %reading+20D –50 kHz bandwidth	
Resistance	Range from 80 Ω to 32 M Ω - accuracy 2%R + 10D –10 ms quick continuity test	
Capacitance	Ranges from 5 nF to 5 mF – basic accuracy 2 %reading+10D	
Other measurements	Frequency, rotation speed, 3.3 V diode test, temperature measurement (with K thermocouple or infrared probe)	
Power		
Measurements	Single-phase and balanced three-phase active power values (with or without neutral), simultaneous display of current	
Harmonic analyser mode		
Multi-channel analysis	2 channels, 31 orders, fundamental frequency from 40 to 450 Hz	
Simultaneous measurements	Total V _{RMS} , THD and selected order (%fundamental, phase, frequency, V _{RMS})	
General specifications		
Screenshots	Up to 100 files in standard ".bmp" format, viewable on the instrument	
PC communication	Isolated optical USB interface –"SX-Metro" PC application software available as an option (version CK)	
Power supply	6 LR6 or 6 AA NiMH batteries – Battery life up to 8 hrs 30 min – Universal mains adapter isolated from the channels – Quick charging in 2 hrs 30 min	
Safety / EMC	Safety according to IEC61010-1 Ed3 – 600 V CAT III – EMC according to EN61000-3, 2001 & EN61326-1, 2006	
Mechanical specifications	214x110x57mm – 1.2 kg with batteries – moulded elastomer casing, IP54 protection	
Warranty	3 years	

References for ordering and state at delivery

Version C: 1 oscilloscope delivered with 1 probe (1/10, 1000 V), 1 BNC/Banana adapter, 1 set of banana leads, 1 mains adapter, 1 set of 6 AA NiMH batteries, 1 "hands-free" bag, 1 CD-Rom containing 1 operating manual and 1 programming manual

Version CK: same as version C plus 1 optical USB communication cable and 1 CD containing the SX-METRO/P software and USB cable drivers

OX5022-C: 1 oscilloscope 2 x 20 MHz
OX5022-CK: 1 oscilloscope, 2 x 20 MHz + USB communication

OX5042-C: 1 oscilloscope 2 x 40 MHz
OX5042-CK: 1 oscilloscope 2 x 40 MHz + USB communication



Electrical Testing and Safety

Assess the electrical safety of installations

The measurements according to the applicable European standards: IEC 60364, EN 61557, NF C 15-100, VDE 0100, NIN/NIV, IEE 17th.

Whatever the environment, electrical installation testers help electricians to certify that the infrastructures under their responsibility are safe.

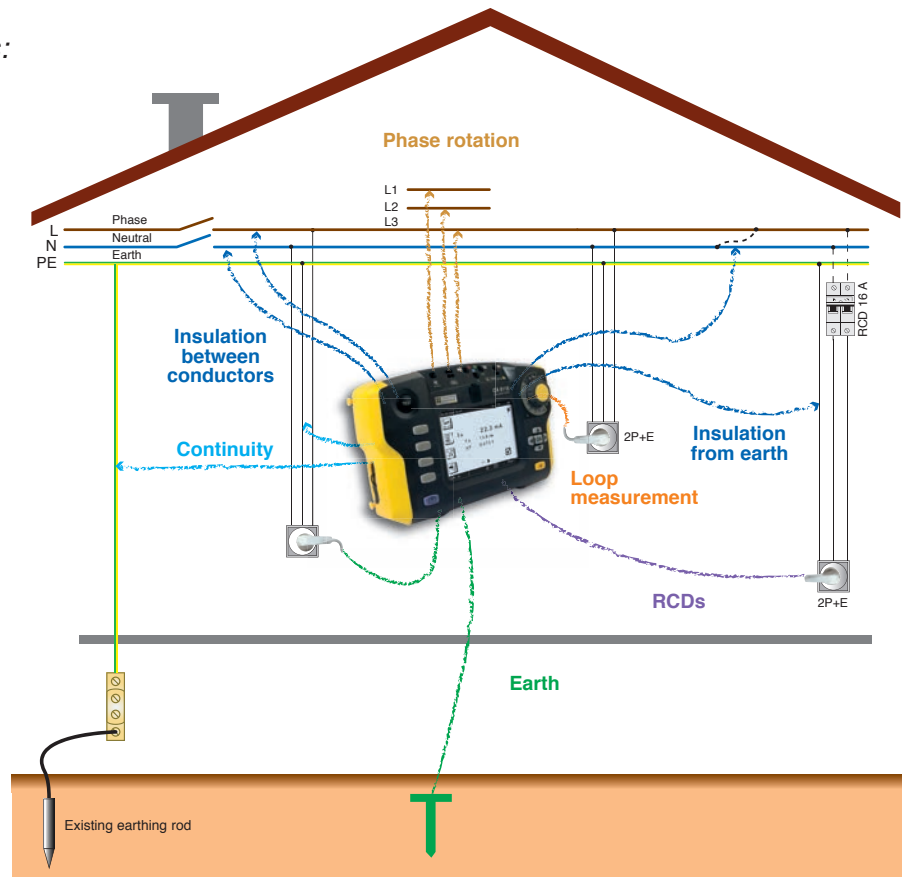

INSULATION (IEC/EN 61557-2)

Measurement with power off

Why measure insulation?

- To check that no conductor has suffered mechanical damage
- To check that all conductors are isolated from earth

Voltage of installation	Test voltage	Insulation required
< 50 V	250 V	≥ 250 kΩ
50 V to 500 V	500 V	≥ 500 kΩ or ≥ 1 MΩ depending on the standards
> 500 V	1,000 V	≥ 1 MΩ

CONTINUITY (IEC/EN 61557-4)

(I ≥ 200 mA)

Why check continuity?

- A PE conductor in good condition and properly connected to the earth bar will drain faults to earth.

EARTH (IEC/EN 61557-5)

Why and how is the earth measured?

- By the single auxiliary rod method (TT & impedant IT networks)
- The Ra must be as low as possible to allow fault currents to flow to earth

PHASE ROTATION (IEC/EN 61557-7)

How are the different phases in a tree-phase network identified?

- By a clear indication of their rotation direction.

RCDs (IEC/EN 61557-6)

Why test RCDs?

- To check that they trip
 - At $I_{test} = I_{\Delta N}$
 - In preventive maintenance, in less than 300 ms for the standard types and 500 ms for the selective types, at a current between $I_{\Delta N}/2$ and $I_{\Delta N}$.

LOOP (IEC/EN 61557-3)

Why measure loops?

- To measure the earth by excess, without using rods
- To calculate the short-circuit current to ensure safety devices are proportionate
- To check fault voltage (with probe connected)

Installation Testers



	C.A 6116N	C.A 6117
CONTINUITY / RESISTANCE		
I rated / Range / Resolution	I > 200 mA / 39.99 Ω / 0.01 Ω / ± (1.5% of measurement + 2 cts) 12 mA / 39.99 Ω & 399.9 Ω / 0.01 & 0.1 Ω / ± (1.5% of measurement + 5 cts) with beep	
Range / Resolution / Accuracy	4 kΩ / 1 Ω / ±(1.5 % of measurement + 5 cts) 40 kΩ - 400 kΩ / 10 Ω - 100 Ω / ±(1.5 % of measurement + 2 cts)	
INSULATION		
Rated voltage	Utest: 50 / 100 / 250 / 500 / 1,000 V DC	
Range / Resolution / Accuracy	0.01 MΩ to 2 GΩ / 10 kΩ to 1 MΩ / ±(5 % of measurement + 3 cts)	
Short-circuit current	≤ 3mA	
EARTH		
3P EARTH	0.50 Ω to 40 Ω / 0.01 Ω / ±(2% of measurement + 10 cts) 40 Ω to 15 kΩ / 0.1 Ω to 1 Ω / ±(2 % of measurement + 2 cts)	
Range / Resolution / Accuracy	15 kΩ to 40 kΩ / 10 Ω / ±(10 % of measurement + 2 cts)	
Others	Measurement of resistance of auxiliary stakes RH & RS (up to 40 kΩ)	
Ufk	Complies with SEV 3569	
1P SELECTIVE EARTH	0.20 Ω to 39.99 Ω - 40 Ω to 399.9 Ω / 0.01 Ω - 0.1 Ω / ±(10 % of measurement + 10 cts) (ISel via clamp)	
Range / Resolution / Accuracy		
LOOP IMPEDANCE (Zs (L-PE) and Zi (L-N or L-L)) – 1P LIVE EARTH		
LIVE EARTH	90 to 500 V / 15.8 to 17.5 Hz - 45 to 65 Hz	
Installation voltage / Freq.		
High-current mode with TRIP	Max. test current: 7.5 A	
Zs (L-PE) & Zi (L-N or L-L)	(0.050) 0.100 Ω to 0.5 Ω / 0.001 Ω / ±(10% of measurement + 20 cts) • 0.5 Ω to 3.999 Ω / 0.001 Ω / ±(5% of measurement + 20 cts) 3.999 Ω / 0.01 Ω / ±(5% of measurement + 2 cts) • 39.99 Ω to 399.99 Ω / 0.1 Ω / ±(5% of measurement + 2 cts)	
Range / Resolution / Accuracy		
NO TRIP mode (Zs (L-PE) only)	Test current: 6 mA – 9 mA – 12 mA (as required) 0.20 Ω to 0.99 Ω / 0.01 Ω / ±(15% of measurement + 10 cts) 1.00 to 1.99 Ω / 0.01 Ω / ±(15% of measurement + 3 cts) 2.00 to 39.99 Ω / 0.01 Ω / ±(10% of measurement + 3 cts) 40.00 Ω to 399.9 Ω / 0.1 Ω / ±(5% of measurement + 2 cts) 400 to 3999 Ω / 1 Ω / ±(5% of measurement + 2 cts)	
Calculation of Ik short-circuit current (PFC (Zs)), I Sc PSCC (Zi)	Fault current and short-circuit current: 0.1 A to 20 kA	
Integrated fuse table	-	Yes
Voltage drop ΔV%(Zi)	-	-40% to + 40%
Others	Measurement of the resistive and inductive components of the Zs and Zi impedances	
AC and A-type RCDs		
Installation voltage / Frequency	90 V to 500 V / 15.8 Hz to 17.5 Hz and 45 Hz to 65 Hz	
IΔn	10/30/100/300/500/650/1000 mA (90V – 280V) or variable - 10/30/100/300/500 mA (280-550V) or variable Ramp and pulse test	
No-trip test	at ½ IΔn – Duration: 1,000 ms or 2,000 ms	
Ramp mode	0,2 to 0,5 x IΔn (Uf) / 0,3 x IΔn to 1,06 x IΔn in increments of 3,3 % x IΔn	
Trip time measurement:	0.2 to 0.5 x IΔn (Uf) / 0.5 x IΔn / 2 x IΔn (selective) / 5 x IΔn	
Range / Resolution / Accuracy	Pulse: 0 to 500 ms / 0.1 and 1 ms / 2 ms, Ramp mode: 0 to 200 ms / 0.1 ms / 2 ms	
B-type RCDs		
Installation voltage / Frequency	-	90 V to 275 V / 15.8 Hz to 17.5 Hz and 45 Hz to 65 Hz
IΔn: ramp / pulse 2 x IΔn	-	10/30/100/300/500 mA
pulse 4 x IΔn	-	10/30/100 mA with pulse 4 IΔn Duration: 150 ms with 4 x IΔn or 300 ms with 2 x IΔn
Test in ramp mode	-	0.2 x IΔn to 2.2 x IΔn
Trip test:	2 x IΔn	IΔN ≤ 200 mA: 2.2 x 2 x IΔN
	4 x IΔn	IΔN > 200 mA: 1.1 x 2 x IΔN IΔN ≤ 100 mA: 2.2 x 4 IΔN
OTHER MEASUREMENTS		
Current by clamps C177/C177A	5.0 mA to 199.9 A (C177A)	
Current by clamp MN77	(1 mA*) 5.0 mA to 19.99 A	
Voltage	0 to 550 V AC/DC / DC and 15.8 to 500 Hz	
Frequency	10 to 500 Hz	
Phase rotation	20 to 500 V AC	
Active power	0 to 110 kW single-phase - 0 to 330 kW three-phase Simultaneous display of voltage and current waveforms	
Harmonics	Voltage and current / up to 50th order / THD-F / THD-R	
GENERAL SPECIFICATIONS		
Display	Large 5.7" backlit graphic colour LCD screen, 320 x 240 points	
Storage/Communication	via USB for data transfer and report creation	
Power supply: rechargeable battery	Lithium-ion 10.8 V rated 5.8Ah	
Battery life	up to 30 hours	
Dimensions / weight	280 x 190 x 128 mm / 2.2 kg	
Protection	IP 53 / IK04	
EMC	IEC 61326-1	
Electrical safety	IEC 61010 -1 – 600 V CAT III – 300 V CAT IV – IEC 61557	

State at delivery

• C.A 6116N • C.A 6117:

1 tester delivered with a carrying bag, 1 type-2 mains power pack / charger, 1 Li-Ion battery pack, 1 USB A/B cable, 1,80 m, with ferrite, 1 three-point cable - 3 safety leads (red, blue and green), 3 test probes, Ø 4mm (red, blue and green), 3 crocodile clips (red, blue and green), 2 elbowed-straight safety leads, 3 m (red and black), 1 three-point Euro mains cable, 1 x 2P EURO mains cable, 1 remote-control probe, 1 wrist strap, 1 scratch-proof film mounted on the instrument, 1 x 4-point hands-free strap, ICT data export software on CD-ROM, 6 operating manuals on CD (one per language), 1 safety datasheet in 20 languages.

* If a voltage is connected to the instrument

References

- C.A 6116N.....> P01145455 A*
- C.A 6117.....> P01145460 A*

*FR version A=X, IT version A= B, CH version A= C, US version A=D

Electrical Testing and Safety

Digital insulation testers



	C.A. 6523	C.A. 6525
	<i>Insulation at 1,000 V, continuity, resistance</i>	<i>Insulation at 1,000 V, continuity, resistance, chronometer</i>
Reference	P01140802D	P01140803D
Voltage	0 TO 600 V _{ac} /b.c	
Insulation	500 / 1,000 V _{DC}	
Range	100 kΩ to 2 GΩ	50 kΩ to 2 GΩ
Continuity	0 to 20 Ω	
Current inversion	yes	
Buzzer	yes	
Cable compensation	yes	
Resistance	0 to 400 kΩ	
Alarms	yes	
Chronometer		0 to 15 min
Display	LCD + bargraph	
Backlighting	yes	
Power supply	6 x 1.5 V batteries	
Safety	IEC 61010 Cat. II 300 V	
Dimensions	211 x 108 x 60 mm	
Weight	830 g	
State at delivery	"Hands-free" carrying bag containing 2 leads, 1 crocodile clip, 1 test probe, 6 x 1.5 V batteries and 1 operating manual	



	C.A 6541	C.A 6543	C.A 6505	C.A 6545	C.A 6547	C.A 6549
	<i>Quantitative and qualitative measurement</i>	<i>Saving of measurements Rechargeable battery</i>	<i>Insulation and leakage current</i>	<i>Insulation, capacitance, current</i>	<i>Storage and communication</i>	<i>For preventive maintenance professionals</i>
Reference	P01138901	P01138902	P01139704	P01139701	P01139702	P01139703
Voltage	1 to 1,000 V _{AC/DC}		1 to 5,100 V _{AC/DC}			
Insulation	50 / 100 / 250 / 500 / 1,000 V _{DC}		500/1,000/ 2,500 / 5,000 V _{DC} + variable from 50 V to 5,100 V _{DC} (10 or 100 V increments)			
Range	2 kΩ to 4 TΩ		10 kΩ to 10 TΩ			
Continuity	0.01 to 40 Ω (buzzer + cable compensation)					
Resistance	0.01 to 400 kΩ					
Capacitance	0.005 to 4.999 μF		0.001 to 49.99 μF			
Current	0.001 nA to 3,000 μA					
Voltage ramp mode						5 steps
R calcul. (ref. T°)						yes
Alarms	yes					
Smoothed display	yes	no		yes		
Chronometer	yes					
Prog. test time	yes					
Quality ratios	DAR / PI			DAR / PI / DD		
R(t)	storage of samples		no	storage of samples		display on screen
R(t) + U(t), I(t), I(u)						
Storage		128 kB		4 kB	128 kB	
Communication		two-way	no		two-way	
Power supply	8 x LR14 batteries		NiMH rechargeable battery			
Safety	IEC 61010-1 Cat. III 600 V IEC 61557		IEC 61010-1 Cat. III 1000 V (Cat. I, 2,500 V)- IEC 61557			
Display	giant LCD + bargraph		giant LCD + bargraph			graphic
Backlighting	yes					
Dimensions	240 x 185 x 110 mm		270 x 250 x 180 mm			
Weight	3.4 kg		4.3 kg			
PC software	no	Dataview® (option)		no	Dataview® (option)	
State at delivery	carrying bag containing: 3 leads 1.5 m long (including one shielded), 3 crocodile clips, 1 test probe + batteries or power cable		carrying bag containing: 3 HV leads 3 m long with large crocodile clips (including one shielded), 1 lead with rear connection (35 cm) + 1 power cable			

DataView® software for C.A 6543, C.A 6547 and C.A 6549

DataView®: the essential tool for configuring and performing the measurements, viewing the data in real time, recovering the recorded data and creating standard or customized measurement reports. > P01102095

Electrical Testing and Safety

Digital insulation testers

- > Wide measurement range from 10 kΩ to 30 TΩ
 - 5 mA charging current
 - Large backlit LCD screen with digital display, bargraph and $R(t)+u(t)$, $i(t)$ and $i(u)$ graphs
 - Automatic calculation of DAR / PI / DD / R (ppm/V) ratios
- > 3 filters to optimize measurement stability



	C.A 6550	C.A 6555
	<i>Expert tools</i>	
Reference	P01139705	P01139706
Voltage	10 kV	15 kV
Insulation	500/1,000/2,500/5,000/10,000 V	500/1,000/2,500/5,000/10,000/15,000 V
Range	10 kΩ to 25 TΩ	10 kΩ to 30 TΩ
Continuity	Yes	
Resistance	Yes	
Capacitance	0.001 - 9.999 μF / 10.00 - 49.99 μF	
Current	Leakage current from 0 to 10 mA	
Voltage ramp mode	3 pre-configurable ramps	
R calcul. (ref. T°)	yes	
Alarms	yes	
Smoothed display	yes	
Chronometer	yes	
Prog. test time	yes	
Quality ratios	DAR / PI / DD / ΔR (ppm/V)	
R(t)	display on screen	
R(t) + U(t), I(t), I(u)	graphic display of curves	
Storage	256 kB, up to 80,000 recordings	
Communication	optically-isolated port for USB and RS232 link	
Power supply	NiMH battery rechargeable with external voltage	
Safety	1,000 V Cat. IV - IEC 61010-1 and IEC 61557	
Backlighting	yes	
Dimensions	340 x 300 x 200 mm	
Weight	6.2 kg	
State at delivery	Delivered with bag containing 2 safety leads 3m long equipped with an HV connector at each end (red / blue), shielded safety lead 3 m long equipped with an HV connector at one end and an HV connector with rear connection (black) at the other end, 3 crocodile clips (red, blue, black), 2 x CAT IV 1000 V test probes (red, black) for voltage measurement, 1 blue lead with rear connection, 1 mains power cable 2 m long, DataView® software, 1 optical / USB communication lead, 1 operating manual in 5 languages on CD-ROM	

Accessories

3 HV leads with croc. clips for 10/15 kV > **P01295466**
 Blue 8 m HV lead with croc. clips > **P01295468**
 Red 8 m HV lead with croc. clips > **P01295469**
 Black 8 m HV lead with croc. clips > **P01295470**
 Blue 15 m HV lead with croc. clips > **P01295471**
 Red 15 m HV lead with croc. clips > **P01295472**

Black 15 m HV lead with croc. clips > **P01295473**
 3 x 3 m HV leads for 10/15 kV > **P01295465**
 50 cm HV lead with rear connection > **P01295467**
 2 red/black test probes > **P01295454Z**
 3 crocodile clips: red/blue/black > **P01103062**
 Bag > **P01298066**

Earth and resistivity testers



		C.A 6460	C.A 6462	C.A 6470N	C.A 6471
Reference		P01126501	P01126502	P01126506	P01126505
3P Method	Range	0.01 to 2,000 Ω		0.01 Ω to 99.99 kΩ	
	Resolution	10 mΩ/100 mΩ/1 Ω		0.01 to 100 Ω	
	Measurement frequency	128 Hz		41 to 513 Hz	
	Coupling measurement	yes		yes	
4P Method	Range	0.01 to 2,000 Ω		0.001 Ω to 99.99 kΩ	
	Resolution	10 mΩ/100 mΩ/1 Ω		0.001 to 100 Ω	
	4P Selective	-		-	yes
Earth measurement with 2 clamps	Range	-		-	0.01 to 500 Ω
	Resolution	no		-	0.01 to 1 Ω
	Measurement frequency	-		-	Auto: 1367 Hz Manual: 128 Hz, 1367 Hz, 1611 Hz, 1758 Hz
Resistivity	Test method	Wenner et Schlumberger		Wenner and Schlumberger with automatic calculation	
	Range	0.01 to 99.9 kΩ		0.01 to 99.9 kΩ	
	Measurement frequency	128 Hz		41 to 128 Hz	
DC resistance measurement	Type of measurement	-		2 or 4 wires	
	Range	no		0.12 Ω to 99.9 kΩ	0.001 Ω to 99.9 kΩ
	Measurement current	-		> 200 mA DC	
Storage	no		512 memory locations		
Communication	no		Optically-isolated USB		
Dimensions / weight	273 x 247 x 127 mm / 2.8 kg / 3.3 kg		272 x 250 x 128 mm / 3 kg / 3.2 kg		
Safety	50 V CAT III, IEC 61010 & IEC 61557		50 V CAT IV, IEC 61010 & IEC 61557		

State at delivery

- **C.A 6460:** delivered with 8 x 1.5 V LR6 batteries and 1 operating manual in 5 languages
- **C.A 6462:** delivered with 1 mains lead for recharging and 1 operating manual in 5 languages
- **C.A 6470N:** delivered with 1 external mains charger, data export software + optical / USB communication lead, 5 operating manuals (one per language) on CD-ROM, 5 simplified operating manuals, each in a different language, 5 descriptive labels, each in a different language
- **C.A 6471:** delivered with 1 external mains charger, data export software + optical / USB communication lead, 2 C182 clamps with 2 safety leads, 5 operating manuals (one per language) on CD-ROM, 5 simplified operating manuals, each in a different language, 5 descriptive labels, each in a different language, 1 carrying bag.

Earth and resistivity kit (100 m kit)

Ref.: P01102024

Compartment bag with space for tester containing: 4 "T"-shaped rods, 4 coils of cable (100 m red, 100 m blue, 100m green, 30 m black), 1 green 10 m cable coiler, 1 mallet, 5 x Ø 4 mm lug/banana plug adapters

Standard 3P-method earth kit

50 m kit Ref.: P01102021

Carrying case containing: 2 "T"-shaped rods, 2 coils of cable (50 m red, 50 m blue), 1 green 10 m cable coiler, 1 mallet, 5 x Ø 4 mm lug/banana plug adapters

100 m kit Ref.: P01102022

Carrying case containing: 2 "T"-shaped rods, 2 coils of cable (100 m red, 100 m blue), 1 green 10 m cable coiler, 1 mallet, 5 x Ø 4 mm lug/banana plug adapters

Accessories

C.A 6471

- MN82 clamp (diam. 20mm)
(delivered with 1 x 2m cable for ES terminal connection) > P01120452
- C182 clamp (diam. 20mm)
(delivered with 1 x 2m cable for ES terminal connection) > P01120333

For the C.A 6471 and C.A 6470N

- Dataview report generation software > P01102058
- Adapter for recharging on vehicle cigarette lighter > P01102036
- Optical / RS communication cable > P01295252
- GB mains power cable > P01295253
- Set of 10 fuses - F 0.63 A – 250 V – 5x20 mm – 1.5 kA > AT0094
- Adapter for charging battery from the mains > P01102035
- Battery pack > P01296021
- Optical / USB communication cable > HX0056-Z

Electrical testing and safety

Instruments 4 Engineers can also provide Cable / Antenna Analyzers and Handheld Spectrum Analysers.
+44 (0) 161 871 7450

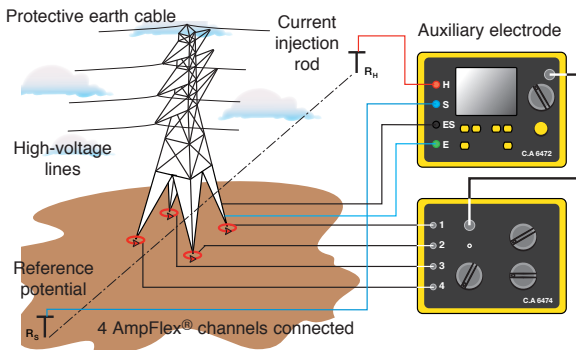

Earth and resistivity tester with adapter for pylon earth measurements



The C.A 6472 can be used to carry out a quick but comprehensive survey of all earthing configurations. When used with the C.A 6474 accessory, it allows users to measure the earth resistance of pylons.

	C.A 6472	Accessory C.A 6474
Reference	P01126504	P01126510
Specifications		
Measurements	Earth / Selective earth / Resistivity / Coupling / Continuity / Ground potential / Pylon earth (with C.A 6474)	Overall pylon earth Earth resistance of each pylon footing Overall line impedance Quality of the protective earth cable connection
Type	Methods: 3P / 4P / 4P with clamp / 2 clamps	Active measurement (injection by C.A 6472) Passive measurement (use of disturbance currents)
Measurement range	0.001 to 100 kΩ (automatic ranging)	
No-load voltage	16 V or 32 V (as required)	
Frequency		41 Hz to 5078 Hz
Frequency sweep		Yes
Auxiliary rod resistance measurement	Yes: 0.01 Ω to 100 kΩ	
U disturbance		
Measurement	0,00 to 65,0 V	
Noise rejection	Yes	
Power supply	Rechargeable NiMH battery	Powered by the C.A 6472
Display	3 digital LCD screens	Provided by the C.A 6472
Storage	512 storage locations	Provided by the C.A 6472
Communication output	Optical / USB link	
Safety	IEC 61010 & IEC 61557	
Dimensions / weight	272 x 250 x 128 mm / 3.2 kg	272 x 250 x 128 mm / 2.3 kg

State at delivery

- **C.A 6472:** delivered with mains adapter + 2P mains plug for battery recharging on mains, data export software + optical / USB communication cable, 2 x C182 clamps, 2 safety leads, 5 operating manuals (one per language) on CD-ROM, 5 simplified operating manuals (one per language), 5 identification labels (one per language), 1 bag.
- **C.A 6474:** delivered with an accessories bag containing 1 connection cable, 6 BNC/BNC cables 15 m long, 4 flexible current sensors (AmpFlex®) 5 m long, 1 set of 12 identification rings for AmpFlex®, 2 cables (5 m green, 5 m black) with safety plugs on winder, 5 spade lug/Ø 4 mm banana plug adapters, 3 clamps, 1 calibration loop, 5 operating manuals and 5 specification labels, each in a different language.

Earth and Resistivity Kit (100m Kit)
see page 21



Accessories

C.A 6472

- MN82 clamp (diam. 20mm) (delivered with 1 x 2m cable for ES terminal connection) > P01120452
- C182 clamp (diam. 20mm) (delivered with 1 x 2m cable for ES terminal connection) > P01120333

For the C.A 6472 and C.A 6474 :

- C.A 6472 – C.A 6474 connection cable > P01295271
- 15 m BNC / BNC cable > P01295272
- 5 m AmpFlex® flexible current sensor for C.A 6474 > P01120550
- Set of 12 AmpFlex® identification rings > P01102045

- Set of 3 adjustable clamps > P01102046
- 5 m green cable for C.A 6474 (E terminal connection) > P01295291
- 5 m black cable for C.A 6474 (ES terminal connection) > P01295292
- Spade lug/Ø 4 mm banana plug adapters > P01102028
- Calibration loop > P01295294
- AmpFlex® flexible current sensors: other lengths available on request

Needing to Test RF exposure from Antennas on Towers? Ask about our RF Personal Safety Monitors!
+44 (0) 161 871 7450

Earth Clamps and Loop Testers



	C.A 6416	C.A 6417
Reference	P01122015	P01122016
Specifications		
Loop ohmmeter	Measurement ranges (Ω) / Resolution (Ω) / Accuracy	
1,500-count display	0.010 to 0.099 / 0.001 / $\pm 1.5\%$ ± 0.01	
	0.10 to 0.99 / 0.01 / $\pm 1.5\%$ $\pm 2r$	
	1.0 to 49.9 / 0.1 / $\pm 1.5\%$ $\pm r$	
	50.0 to 99.5 / 0.5 / $\pm 2\%$ $\pm r$	
	100 to 199 / 1 / $\pm 3\%$ $\pm r$	
	200 to 395 / 5 / $\pm 5\%$ $\pm r$	
	400 to 590 / 10 / $\pm 10\%$ $\pm r$	
	600 to 1150 / 50 / Approx. 20 %	
	1200 to 1500 / 50 / Approx. 25 %	
Frequency	Measurement frequency: 2083 Hz / Transposition frequency: 50, 60, 128 or 2083 Hz	
Loop inductance measurement	Measurement ranges (μH) / Resolution (μH) / Accuracy	
	10 to 100 / 1 / $\pm 5\%$ $\pm r$	
	100 to 500 / 1 / $\pm 3\%$ $\pm r$	
Contact voltage	Measurement ranges (V) / Resolution (V)	
	0.1 to 4.9 / 0.1	
	5.0 to 49.5 / 0.5	
	50.0 to 75.0 / 1	
Ammeter	Measurement ranges (A) / Resolution (A) / Accuracy	
Measurement ranges (A) / Resolution (A) / Accuracy	0.200 to 0.999 mA / 1 μA / $\pm 2\%$ $\pm 50 \mu\text{A}$	
4,000-count display	1.000 to 2.990 mA - 3.00 to 9.99 mA / 10 μA / $\pm 2\%$ $\pm 50 \mu\text{A}$	
	10.00 to 29.90 mA - 30.0 to 99.9 mA / 100 μA / $\pm 2\%$ $\pm r$	
	100.0 to 299.0 mA - 0.300 to 0.990 A / 1 mA / $\pm 2\%$ $\pm r$	
	1.000 to 2.990 A - 3.00 to 39.99 A / 10 mA / $\pm 2\%$ $\pm r$	
Setup		
Modes	Standard or advanced	
Alarms	Configurable on Z, V and A	
Buzzer	Active	
HOLD	Manual or automatic PRE-HOLD	
Automatic power-off	Active / Inactive	
General specifications		
Display	152-segment OLED. Active area 48 x 39 mm	
Max. clamping diameter	\varnothing 35 mm	
Storage	300 time/date-stamped measurements	2,000 time/date-stamped measurements
Communication	-	Bluetooth Class 2
Power supply	4 x 1.5 V LR6 (AA) alkaline batteries or 4 x Ni-MH batteries	
Battery life	1440 x 30-second measurements	
Calibration	Automatic at start-up	
Electrical safety	IEC 61010 600 V CAT IV	
Protection	IP40	
Dimensions	55 x 95 x 262 mm	
Weight	Approx. 935 g with batteries	

State at delivery

- **C.A 6416:** 1 clamp delivered in a hard case with 4 x 1.5 V batteries, 1 CD-Rom containing the operating manual in 5 languages
- **C.A 6417:** 1 clamp delivered in a hard case with 4 x 1.5 V batteries, 1 CD-Rom containing the operating manual in 5 languages and the GTT software with simplified driver

Accessoires

- CL1 calibration loop > **P01122301**
- Bluetooth USB modem > **P01102112**
- DataView > **P01102095**
- Hard case > **P01298080**

NEW

Locate hidden cables

Comprising a transmitter and a receiver, the LOCAT-N provides digital, visual and audio indication of the presence of cables or ducts so that you can follow them intuitively.



	C.A 6681 LOCAT-N
Reference	P01141626
C.A 6681E transmitter	
Screen	LCD screen with display of functions and bargraph
Output signal frequency	125 kHz
External voltage measurement range	12 to 600 V _{ACDC}
Functions	Digital coding of signals for easy signal identification, selection of transmission signal code, torch function
Power supply	9 V battery
Dimensions	190 x 89 x 42.5 mm
Weight	420 g with battery
Electrical safety	300 V CAT III
C.A 6681R receiver	
Screen	Backlit LCD with display of functions and bargraph, transmission code, receiver and transmitter battery-charge status
Detection Depth	
> Single-pole application	0 to 2 m
> Two-pole application	0 to 0.5 m
> Simple looping line	Up to 2.5 m
Identification of mains voltage	Approximately 0 to 0.4 m
Functions	Automatic shutdown, automatic or manual adjustment of reception sensitivity, torch function
Power supply	6 x 1.5 V AAA batteries
Dimensions	241.5 x 78 x 38.5 mm
Weight	360 g with batteries

State at delivery

- **C.A 6681 LOCAT-N:** delivered in a hard case with 1 set of red/black 4 mm isolated banana leads (straight male / elbowed male), 1 set of 2 crocodile clips, 1 stake for earthing, 1 x 9 V battery, 6 x 1.5 V AAA batteries, 1 measurement adapter for B22 socket (bayonet), 1 adapter for E14 socket (screw-in), 1 mains socket adapter and 1 operating manual in 5 languages.



Electrical Testing and Safety

Micro-ohmmeters



	C.A 6240	C.A 6250
	<i>Low-level resistance measurements</i>	
Reference	P01143200	P01143201
Measurement method	4-wire method	
Resistance	400 $\mu\Omega$ to 400.0 Ω	1 $\mu\Omega$ to 2,500 Ω
Resolution	1 $\mu\Omega$	0.1 $\mu\Omega$
Accuracy	0.25 %	0.05 %
Current	10 mA to 10 A	1 mA to 10 A
Current inversion	Yes	No, but automatic compensation of eddy currents
Measurement mode	Inductive, non-inductive, non-inductive with automatic triggering	
Temperature compensation	no	Manual or with Pt 100 probe
Power supply	NiMH rechargeable battery	
Electrical safety	IEC 61010-1 / Cat III 50 V	
Dimensions	270 x 250 x 180 mm	
Weight	4.5 kg	4 kg
State at delivery	Mains power cable / leads with Kelvin clamps / software / optical /USB communication cable / bag	

Electrical equipment tester



	DTR 8510
	<i>Digital ratiometer for transformers</i>
Range of ratios (VT)	Automatic: 0.8000 to 8,000:1
Accuracy (VT)	Range of ratios Accuracy (% of reading)
	0.8000 to 9.9999 $\pm 0.2\%$
	10.000 to 999.99 $\pm 0.1\%$
	1000.0 to 4999.9 $\pm 0.2\%$
	5000.0 to 8000.0 $\pm 0.25\%$
Range of ratios (TC)	Autorangeing: 0.8000 to 1000.0
Accuracy (TC)	$\pm 0.5\%$ of reading
Excitation signal	VT mode: 32 Vrms max CT mode: Auto level 0 to 1 A, 0.1 to 4.5 Vrms
Excitation current display	Range: 0 to 1,000 mA; Accuracy: $\pm (2\% R + 2\text{ mA})$
Excitation frequency	70 Hz
Display	Alphanumeric LCD, 2 lines of 16 characters with adjustment of contrast and backlighting. Easy to read in both daytime and nighttime conditions
Available languages	French, English, Spanish, Italian, German, Portuguese
Measurement method	According to IEEE Std C57, 12.90™ -2006 standard
Power supply	Two rechargeable batteries: 12 V, NiMH, 1650 mAh
Battery life	Up to 10 hrs in continuous operation, low-battery warning
Battery charger	Universal input (90 to 264 Vrms), smart charger
Charging time	< 4 hours for full charge
Storage	10,000 tests
Date / time	Power supplied by dedicated battery, real-time clock
Communication	USB 2.0, optical isolation, 115.2 kB
Software	Delivered with DataView® analytical software
Dimensions / Weight	272 x 248 x 130 mm / 3.7 kg
Connection	XLR connectors
Leads	Screened H and X leads, length 4.6 m (15 ft), equipped with colour-coded crocodile clips
Casing	Rugged polypropylene casing, UL 90 V0
Vibrations	IEC 68-2-6 (1.5 mm at 55 Hz)
Shocks	IEC 68-2-27 (30 G)
Falls	IEC 68-2-32 (1 m)
Protection rating	IP 40 with cover open as per EN 60529 IP 53 with cover closed as per EN 60529
Safety	EN 61010-1, 50 V CAT IV; pollution degree 2
State at delivery	Delivered with a carrying bag containing 1 set of 4.6 m leads with crocodile clips, 1 external battery charger with mains power cable, 1 USB cable, 1 NiMH battery datasheet, 1 operating manual and DataView software on CD-Rom

Power, Energy, Disturbances

Symptoms of disturbances on an electricity network

Qualimetry is a major focus for many companies, not least because of its financial benefits. Before raising the issue of a diagnosis of their electrical system, it is worth knowing the different symptoms, listed in the table below, which indicate faults in an installation.

SYMPTOMS	POSSIBLE ORIGINS																	
	Flicker	Brown-outs	Under-voltage	Over-voltage	Atmospheric surges	Harmonics	Inter-harmonics	Harmonic-polar harmonics	Micro-outages	Short power cuts	Long and very long outages	HF spikes	Power surges	DC component	Three-phase unbalance	Frequency variations	Excess reactive power	EMC
Processes operate erratically	●				●			●										
Random stoppages of process equipment	●	●		●														
Process stoppages				●	●				●	●								
Damage to equipment				●	●	●				●			●	●				
Overheating and noise from equipment		●	●		●	●	●							●			●	
Malfunctions on motors		●			●									●	●			
Abnormal vibration and noise on motors		●			●	●								●				
Stoppages of motors								●	●				●					
Malfunction of the electronic					●			●					●					●
Malfunction of electronics								●			●	●		●				●
Erratic operation of protection systems			●				●					●		●			●	
Untimely tripping of protection systems													●					
Non-operation of protection systems																		
Triggering of arcs				●			●		●	●								●
Problems with monitors	●																	●
Problems with radio-communications				●							●							●
Computer and telecom interference			●	●	●			●	●		●							●
Destruction of PCBs			●					●			●							●
Destruction of computer hardware			●		●			●			●	●						
Flicker of lighting	●								●									
Electrocution				●			●											
Fire of electrical origin				●			●						●					

The standards

EN 50160

Defines the measurements required to qualify the voltage delivered by the electrical grid: rms voltage, outages, voltage dips, swells, flicker, frequency, harmonics (up to the 40th order) and three-phase system unbalance.

IEC 61000-4-30

Defines the methods and accuracies for the power quality measurements listed in the EN 50160 standard (rms voltage, outage, voltage dips and swells, unbalance,...).

IEC 61000-4-7

Defines the method for measuring harmonics and interharmonics

IEC 61000-4-15

Defines the flicker measurement method including:

- ◇ **Pst short-term flicker indicator:**
Quantitative evaluation of the flicker over a 10-minute period.
- ◇ **Plt long-term flicker indicator:**
Quantitative evaluation of the flicker over a 2-hour period, using 12 successive short-term flicker (Pst) values.

Power, Energy, Disturbances

Energy analysers for three-phase networks

QUALI STAR+

- 5 voltage inputs and 4 current inputs
- 10-minute Inrush mode
- Calculation of distorting power

IEC 61010
1000 V CAT III
600 V CAT IV

CAT
IV



IEC 61000-4-30

IP
67

	C.A 8331 P01160511	C.A 8333 P01160541	C.A 8336 P01160591	C.A 8435 AMP450 ⁽¹⁾ P01160585
Reference	P01160511	P01160541	P01160591	P01160585
Number of channels	3U / 4I		4U / 4I	
Number of inputs	4V / 3I		5V / 4I	
Voltage (TRMS AC+DC)	2 V to 1,000 V			
Voltage ratio	Up to 500 kV			
Current (TRMS AC+DC)				
MN clamps	MN93 : 2 TO 200 AAC ; MN93A : 0,005 AAC TO 100 A _{AC}			
C193 clamp	1 A to 1 000 A _{AC}			
AmpFlex® or MA clamps	100 mA TO 10 000 A _{AC}		30 A TO 6 500 A _{AC}	
PAC93 clamp	1 A TO 1 000 A _{AC+DC}			
E3N clamp	50 mA TO 10 A _{AC/DC} – 100 mA TO 100 A _{AC/DC}			
Current ratio	Up to 60 kA			
Frequency	40 Hz to 69 Hz			
Power values	W, VA, var, VAD, PF, DPF, cos φ, tan φ			
Energy values	Wh, varh, VAh, VADh			
Harmonics	Yes			
THD	Yes, orders 0 to 50, phase			
Expert mode	-		Yes	
Transients	-	50		210
Flicker (Pst and Plt)			Yes	
Inrush mode	-	Yes over 4 periods		Yes > 10 minutes
Unbalance			Yes	
Recording Min/Max			Yes	
of a selection of parameters at max. sampling rate	4 hrs to 2 weeks	A few days to several weeks		2 weeks to several years
Alarm	-	4,000 of 10 different types		10,000 of 40 different types
Peak			Yes	
Vectorial representation			Automatic	
Display	TFT colour ¼ VGA screen, 320 x 240, diagonal 148 mm			
Capture of screens and curves	12			50
Electrical safety	IEC 61010 1 000 V CAT III / 600 V CAT IV			
Protection	IP53 / IK08		IP67	
Languages	More than 27			
Battery life	Up to 13 hours			
Communication interface	USB			
Power supply	9.6 V NiMH rechargeable battery or mains power supply			
IEC 61000-4-30	-	Yes with DataView® software		-
Dimensions	240 x 180 x 55 mm		270 x 250 x 180 mm	
Weight	1.9 kg		3.7 kg	
Warranty	3 years			

(1) with AmpFlex® 450 sensor

State at delivery

- **C.A 8336 · C.A 8333 · C.A 8331 - Models without sensors:** Qualistar+ analyser delivered with a bag for accessories, 5x4 mm banana voltage leads 3 m long, 5 crocodile clips, 12-colour identification kit for the leads and inputs, anti-scratch screen-protection film (mounted), USB cable, mains power cable, mains power pack, safety datasheet, 1 CD containing multi-language operating manual and 1 CD containing PC software for data recovery (Power Analyzer Transfer).

- **C.A 8435 AMP450:** Delivered with bag no. 22, USB cable, IP67 mains power cable, 4 AmpFlex® 450 IP67 A196 current sensors, 5 x IP67 BB196 black banana leads, 5 lockable crocodile clips, 12-colour identification kit for the leads and inputs, anti-scratch screen-protection film (mounted), USB cable, mains power cable, mains power pack, safety datasheet, 1 CD containing multi-language operating manual and 1 CD containing PC software for data recovery (Power Analyzer Transfer).



Logiciels

The measurements performed with the Qualistar models can be processed using two software products:

Power Analyzer Transfer (standard) and **DataView**® (option).

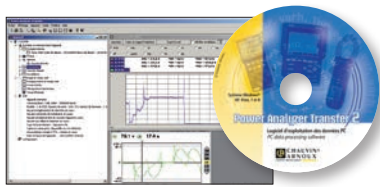

Power Analyzer Transfer

For transferring data onto a PC and communicating in real time via USB.

Supplied with the Qualistar+ models

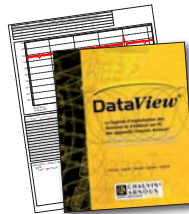

DataView®

Powerful configuration, transfer and measurement data processing software, with generation of reports according to the voltage quality standards as well as EN5010 reports (C.A 8333/8230)

DataView® is compatible with other Chauvin Arnoux® products:

- C.A 8220 & C.A 8230 power analysers
- F400 and F600 multimeter clamps
- and other measuring instruments

Minimum operating system required: Windows® 2000, Windows® XP, Windows® Vista, Windows® 7 and 8.

Reference **P01102095**

Essailec

An accessory for all the Qualistar+ models

A lead with an ESSAILEC plug can be used to perform tests without disturbing or interrupting the power supply circuit on meters and protection relays installed in the secondary circuits of current or voltage transformers. The main advantage is the speed and simplicity of measurement with maximum user safety.



Reference **P01102131**

Clamps for Qualistar+



	MN93	MN93A	MiniFlex® MA193-250	MiniFlex® MA193-350	PAC93	AmpFlex® A193-450	AmpFlex® A193-800	C193	E3N
Reference	P01120425B	P01120434B	P01120580	P01120567	P01120079B	P01120526B	P01120531B	P01120323B	P01120043A
Measurement range	0.5 to 200 A _{ac}	0.005 to 100 A _{ac}	100 mA to 10k A _{ac}	100 mA to 10k A _{ac}	1 A to 1000 A _{ac} 1 A to 1300 A _{ac}	100 mA to 10 k A _{ac}	100 mA to 10k A _{ac}	1 A to 1000 A _{ac}	50 mA to 10 A _{ac/dc} 100 mA to 100 A _{ac/dc}
Clamping Ø / length	20 mm	20 mm	Ø 70 mm / 250 mm	Ø 100 mm / 350 mm	1 x Ø 39 mm 2 x Ø 25 mm	Ø 140 mm / 450 mm	Ø 250 mm / 800 mm	52 mm	11,8 mm
IEC 61010	600 V CAT III / 300 V CAT IV	600 V CAT III / 300 V CAT IV	1000 V CAT III / 600 V CAT IV	1000 V CAT III / 600 V CAT IV	600 V CAT III / 300 V CAT IV	1000 V CAT III / 600 V CAT IV	1000 V CAT III / 600 V CAT IV	600 V CAT IV	600 V CAT III / 300 V CAT IV

Additional accessories

AmpFlex® A196 450 mm IP67	> P01120552	Bag no. 21	> P01298055	Kit comprising banana leads (x 4), crocodile clips (x 5) and 1 set of coloured rings	> P01295476
E3N adapter	> P01102081	Bag no. 22	> P01298056	Set of plugs (C.A 8435)	> P01102117
E3N mains power pack	> P01120047	USB-A USB-B cable	> P01295293	Mains power pack (C.A 8335)	> P01102057
Battery pack	> P01296024	5 A unit	> P01101959	IP67 mains power cable (C.A 8435) ...	> P01295477
Qualistar screen film	> P01102059	Lockable crocodile clips (x 5)	> P01102099		
Set of rings-inserts	> P01102080	Kit comprising banana leads (x 5), crocodile clips (x 5) and 1 set of coloured rings	> P01295483		
Set of 5 x IP67 banana leads 3 m long (BB196)	> P01295479				

Power, Energy, Disturbances

Power analysers for three-phase electrical networks



	C.A 8220	C.A 8230
	<i>Specially designed for motor maintenance Access to all the measurements simultaneously Low-resistance and high-current measurements</i>	
	<i>Large colour screen Intuitive use Excellent price-quality ratio Recording Alarms</i>	
Reference	P01160620	P01160630
Voltage	6 VRMS to 600 VRMS AC+DC	
Accuracy	± (0.5 % + 2 cts)	
AC current	5 mA to 6,500 A	
Accuracy	± (0.5 % + 1 ct)	
DC current	1 A to 1,400 A	
Accuracy	± (1% + 1 A)	
Values	Min, max, avg, Peak (+ and -), crest factor	
Fundamental frequency	40 Hz to 70 Hz	
Display	Backlit LCD with 3 displays of 173 segments	VGA colour LCD (320 x 240)
Single-phase and balanced three-phase	Yes	
Power measurements	W, VA, var, PF, DF, THD, cos φ	
Energy	varh, VAh, Wh	
Harmonics	Up to 50th order	
Recording		up to several days
Alarms		4,096
PST flicker		Yes
Functions	Phase rotation yes, with display of phase order for three-phase systems	
Motor inrush current display		Yes
Motor rotation speed	6 RPM to 120 kRPM ± (0.5 %)	
Temperature (Pt 100)	-200 °C to +850 °C ± (1 % + 10 cts)	
Resistance (winding)	0 Ω to 2,000 Ω ± (0.5 % + 2 Ω)	
Measurement storage	Yes	
Use		
Ambient temperature	23 °C ± 3 K	
Relative humidity	45 % to 75 %	
Protection rating	IP54	
USB optical port	Yes	
Safety	IEC 61010-1, 600 V- cat. III	
Power supply	6 AA batteries	Rechargeable batteries, battery life up to 40 hours
Weight	840 g (with batteries)	880 g (with rechargeable batteries)
Dimensions	211 x 108 x 60 mm	
State at delivery	Delivered with 6 AA batteries installed, 1 red banana lead (straight-straight), 1 black banana lead (straight-straight), 2 x 4 mm test probes (1 red, 1 black), 2 crocodile clips (1 red, 1 black), 1 USB optical cable, PAT software	Delivered with a carrying bag, 6 x 1.2 V rechargeable batteries installed, 1 red banana lead (straight-straight), 1 black banana lead (straight-straight), 2 x 4 mm test probes (1 red, 1 black), 2 crocodile clips (1 red, 1 black), 1 mains adapter, USB optical cable, PAT software



Accessories

For DataView® software and E3N clamp, see page 27

Red and black 4 mm test probes	> P01101855
Red and black crocodile clips	> P01101848
Red and black 4 mm banana/banana leads	> P01295091
MN93A BK clamp	> P01120434B
MN93 BK clamp	> P01120425B
AmpFlex® A 193 450 mm BK	> P01120526B
AmpFlex® A 193 800 mm BK	> P01120531B
PAC93 BK clamp	> P01120079B
C193 BK clamp	> P01120323B
Mains adapter	> P01160640
RPM probes C.A 1711	> P01102082
Temperature probes	> HX0091
E3N clamp	> P01120047

Power and Energy Loggers

- > Single-phase, split-phase and three-phase installations
- > Installation without cutting off the mains power supply
- > Harmonic analysis up to the 50th order
- > Bluetooth, Ethernet and USB Communication
- > Automatic recognition of the sensors connected
- > Recording on SD card



	PEL102 (without current sensors)	PEL103 (without current sensors)
Référence	P01157152	P01157153
Display	Without	With triple digital display
Installation types	Single-phase, split-phase, three-phase with or without neutral, and many other specific configurations	
Number of channels	3 Voltage inputs / 3 Current inputs (neutral current calculated)	
Measurements		
Network frequency	DC, 50 Hz, 60 Hz & 400 Hz	
Voltage (Measurement ranges/ Best accuracy)	10.00 to 1000 V _{AC/DC} / +/- 0.2 % + 0.5 V	
	2.000 to 240.0 A _{AC} / +/- 1.2 % + 1 A	
Current	0.005 A _{AC} to 5.000 A _{AC} - 0.100 A _{AC} to 120.0 A _{AC} / +/- 1.2 % + 2 mA	
	3.000 A to 1200 A _{AC} / +/- 0.5 %	
	100.0 mA to 10.00 kA _{AC} / +/- 1.2 % + 70 mA	
	10.00 A to 1000 A _{AC} - 10.00 A to 1400 A _{DC} / +/- 1.7 % + 1 A	
	50.00 mA to 10.00 A _{AC/DC} - 100.0 mA to 100.0 A _{AC/DC} / +/- 3.2 % + 70 mA	
Calculated measurements		
Ratios	Up to 650,000 V / up to 25,000 A	
Power	10 W to 10 GW / 10 var to 10 Gvar / 10 VA to 10 GVA	
Energy	Up to 4 EWh / 4 EVAh / 4 Evarh (E = 1018)	
Phase	cos , tan , PF	
Harmonics	Up to 50th order	
Additional functions		
Phase order	Yes	
Min / Max	Yes	
Mounting	Magnet, hook	
Recording		
Sampling / Acquisition rate / Aggregation	128 samples/period - 1 measurement/s – from 1 min to 60 min	
Storage	SD Card, 2 GB (SD-HC Card up to 32 GB)	
Communication	Ethernet & Bluetooth	
Power supply	110 V - 250 V (+10 %, -15 %) @ 50-60 Hz & 400 Hz	
Safety	IEC 61010 600 V CAT IV – 1,000 V CAT III	
Mechanical specifications		
Dimensions	256 x 125 x 37 mm without sensor	
Weight	900 g	950 g
Casing	IP54 , UL (pending)	

State at delivery

• **PEL102** and **PEL103**: 4 measurement leads (straight banana / straight banana – 3 m long – black), 4 crocodile clips (black), 1 SD card (2 GB), 1 set of rings and inserts (for ends of leads and current sensors), 1 mains cable, 1 USB cable (Type A / Type B), 1 MultiFIX mounting systems, 1 operating manual (on CD), 1 bag, 1 safety datasheet, PEL Transfer PC software, 1 quick start-up guide, 1 SD MN adapter (depending on model).

Accessoires

DataVIEW® software..... >	P01102095	AmpFlex®	
Bag No 23..... >	P01298078	A193-800 mm clamp..... >	P01120531B
Leads/clamps kit..... >	P01295476	Mini-AmpFlex®	
Set of id. rings/inserts... >	P01102080	MA193, 200 mm..... >	P01120580
5 A box..... >	P01101959	E3N clamp..... >	P01120043A
MN93 clamp..... >	P01120425B	PEL100 mains	
MN93A clamp..... >	P01120434B	adapter..... >	P01102134
C193 clamp..... >	P01120323B	MultiFIX..... >	P01102100Z
PAC93 clamp..... >	P01120079B	Mains power cable..... >	P01295174
AmpFlex®			
A193-450 mm clamp..... >	P01120526B		



PEL100 mains adapter

To self-power the PEL via the voltage measurement channel

Environmental Measurements

Non-contact thermometers



	C.A 871	C.A 879	C.A 1864	C.A 1866
	For both industry and self-employed electricians		Precise laser sighting	Measurements up to 1,000 °C
Reference	P01651302Z	P01651805Z	P01651813	P01651814
Distance/spot ratio	8/1	12/1	30/1	50/1
Emissivity	0.95		0.1 to 1	
Measurement range	-40 to +538 °C	-50 to +550 °C	-50 to +1,000 °C	
Resolution	0.1 °C to 100 °C, 1 °C above		0.1 °C	
Accuracy	± 2.5 % ± 2 °C		± 1.5 % ± 2 °C	
Functions	Laser sight		yes	
	Continuous measurement		yes	
	Max. value		yes	
	Min. value		yes	
	Average		yes	
	Alarms		yes	
	Auto hold		yes	
	Choice of measurement unit		°C or °F	
Display	2,000 cts		20,000 cts	
	Backlighting		yes	
Dimensions	160 x 82 x 41.5 mm	230 x 100 x 56 mm	230 x 100 x 56 mm	
Weight	180 g	290 g	290 g	

State at delivery

- C.A 871 and C.A 879: delivered with 9 V battery + soft case
- C.A 1864 and C.A 1866: Delivered with 9 V battery, wrist strap, soft case and operating manual



Delivered with 9 V battery, wrist strap, soft case and operating manual

Tachometers

- Measurement up to 100,000 RPM
- Contact and non-contact measurement
- Wide range of functions available: rotation speed, linear, counting, frequency, period
- Possibility of programming and storage capacity for the C.A 1727
- USB link for processing the records on PC for the C.A 1727



	C.A 1725	C.A 1727
Reference	P01174810	P01174830
RPM function	Range: 6 to 100,000 RPM	
	Accuracy: 10-4 R ± 6 cts	
m/min function	Range: 0.6 to 60,000 m/min	
	Accuracy: 10-4 R ± 1 increment	
Hz function	Range: 0.1 to 10,000 Hz	
	Accuracy: 4 x 10-5 R ± 4 cts	
ms function	Range: 0.1 to 10,000 ms	
	Accuracy: 10-4 R ± 5 cts	
Ratio function	Range: 10 to 10,000 %	
	Accuracy: 0.1 % to 1 %	
Counting function	Range: 0 to 99,999 events	Accuracy: ± 1 event
Functions	Min., Max., HOLD, Smoothing	
	High and low alarms	
Storage	4,000 alarms	
Dimensions / Weight	21 x 72 x 47 mm / 250 g	

State at delivery

- C.A 1725 and C.A 1727: delivered in a hard case with 1 FRB F connector, a 9 V battery, 1 set of 15 reflective strips (length: 0.1 m), 1 operating manual on CD and 1 printed quick startup guide + only available for C.A 1727: 1 TACHOGRAPH software on CD-Rom

Accessories

Mechanical accessories kit	> P01174902	FRB F connector	> P01101785
End fittings (set of 3)	> P01174903	TACHOGRAPH software on CD-Rom	> P01174835
Reflective strips (15 x 0.1 m strips)	> P01101797	Cable: USB-A to USB-B	> P01295293

Lightmeters



	C.A 811	C.A 813
	Measures up to 20,000 lux	Measures up to 200,000 lux
Reference	P01172201Z	P01172401Z
Measurement range	4 ranges: 0 to 20,000 lux	5 ranges: 0 to 200,000 lux
Accuracy (incandescent lamp)	± 3 % + 10 cts	
Accuracy (other light sources)	18 % + 2 cts	11 % + 2 cts
I.C.I. spectral correction	yes	
Incidence correction	yes	
Max. value	yes	
Choice of measurement unit	lux or Fc	
Display	2,000 counts	
Dimensions	173 x 60.5 x 38 mm	
Weight	214 g	223 g

State at delivery

- C.A 811 et C.A 813 : with shockproof protective sheath

Indoor air quality (CO₂, temperature, humidity)

Monitor the air around you
for a healthy environment.

NEW



Types of use		CO ₂ measurement	
Point measurement Monitoring	Quick measurement and display of the CO ₂ , temperature and relative humidity values	Measuring principle	Non-diffusive infrared (NDIR) technology
Monitoring	<p>1D mode: indication of CO₂ confinement Visual (two-colour backlighting & pictograms) and/or audible indication of high confinement when the CO₂ concentration is between 1,000 ppm and a 1,700 ppm threshold.</p> <p>3D mode: indication of optimum comfort zone on the basis of the hygrothermal criteria and the CO₂ concentration.</p> <p>Energy-saving (ECO): for fixed use on battery power, the product performs measurements every 10 minutes over a programmable time range for a battery life of up to one year.</p>	Type of sensor	Double-beam infrared cell sensor
Logger	<p>Triggering of programmed recording (P_REC) The start date, recording rate and end date can be customized with the PC software or the Android application. Possibility of locking the display in this mode (no values displayed).</p> <p>Manual triggering (M_REC) Manual start and stop controls on the product. Recording is performed at the rate of the mode currently selected.</p>	Measurement range	0 to 5,000 ppm
		<p>Temperature measurement</p> <p>Type of sensor</p>	CMOS
		measurement range	-10 °C to +60 °C
		Accuracy	± 0,5 °C
		Resolution	0.1 °C
		Humidity measurement	
		Type of sensor	Capacitive
		Measurement range	5 to 95 % HR
		Accuracy	± 2 % HR
		Resolution	0.1 % HR



C.A 1510

P01651010



C.A 1510W

P01651011

Reference	C.A 1510 P01651010	C.A 1510W P01651011
Specifications		
Recording interval	Customizable from 1 minute to 2 hours	
Storage	More than 1 million measurements	
Buzzer	Yes	
Units	°C or °F	
Backlighting Display Hold function Min-Max	Yes	
Automatic power-off	Yes (in portable mode only)	
General specifications		
Casing colour	Charcoal-grey	White
Product operating range	Temperature: -10 °C to +60 °C – Humidity: 5 to 95 %RH	
Dimensions / weight	125 x 65.5 x 32 mm / 190 g with batteries	
Protection	IP40	
Compliance	IEC 61010-1 for 50 V in Category II – IEC 61326-1 – Compliance with French decree no. 2012-14	
Power supply	- Alkaline batteries: 2 x 1.5 V AA / LR6 or rechargeable battery - Connection to mains possible with mains / micro USB adapter supplied as standard	
Interfaces	2 communication modes possible: - Bluetooth wireless communication - USB link; the product is then recognized as a USB key for easy file transfer	
Mounting	C.A 1510 casing equipped with a magnet, a wall-suspension system and a slot for hanging the product. A wall support for use with a padlock (padlock not supplied) is available as an accessory, as is a desktop stand (supplied as standard with the C.A 1510W).	
Functions of the AQR (Air Quality Report) software supplied as standard	Graphic representation or as table of values – Data export – Real-time mode Calculation of the confinement index with selection of presence periods – Report generation	

State at delivery

- **C.A 1510:** delivered in a small-format metal case with 2 x LR6 batteries, USB mains adapter, USB-micro USB cable 1.80 m long, quick start-up guide, mini-CD containing the AQR software and the user's guides (one file per language), verification attestation.
- **C.A 1510W:** delivered in a cardboard box with 2 x LR6 batteries, USB mains adapter, USB-micro USB cable 1.80 m long, desktop stand, wall support, quick start-up guide, mini-CD containing the AQR software and the user's guides (one file per language), verification attestation.



Accessories and replacement parts

In-situ calibration kit (fits into in the metal case)	> P01651022
Hard case	> P01298071
Desktop stand	> P01651021
Wall support	> P01651020
USB mains adapter	> P01651023
USB-Bluetooth adapter	> P01102112

Current measurement

AC and AC/DC current measurement



Series	Model	Input ⁽¹⁾						Output / Connections			Specific features					To order			
		Very low current	Low current	Medium current	High current	~ AC	DC	Current	Voltage	Leads + safety plug Ø 4 mm ⁽³⁾	Female sockets Ø 4 mm	BNC connector (oscilloscope)	Transformation ratio (input/output)	Output protected against overvoltage	Automatic DC zero (low phase shift)		Power measurement	Bandwidth (frequency in Hz)	Typical accuracy
AC		MINI 01		2 to 150 A				0.15 A AC				1,000/1					48 Hz... 500 Hz	≤ 2.5 %	P01051101Z
		MINI 02	50 mA to 100 A				0.15 A AC					1,000/1					48 Hz... 10 Hz	≤ 1 %	P01051102Z
		MINI 03		1 to 100 A				0.1 V AC				1 A / 1 mV						≤ 2 %	P01051103Z
		MINI 05	5 mA to 10 A 1 to 100 A				10 V A AC 0.1 V AC					1 mA/1 mV 1 A/1 mV					48 Hz... 500 Hz	≤ 3 % ≤ 2 %	P01051105Z
		MINI 09		1 to 150 A				15 V DC				1 A/100 mV						≤ 4 %	P01051109Z
		MN08		0.5 to 240 A				0.2 A AC				1,000/1					40 Hz... 10 kHz	≤ 1 %	P01120401
		MN09		0.5 to 240 A				0.2 A AC				1,000/1					40 Hz... 10 kHz	≤ 1 %	P01120402
		MN11		0.5 to 240 A				0.2 A AC				1,000/1					40 Hz... 10 kHz	≤ 2 %	P01120404
		MN12		0.5 to 240 A				2 V AC				1A/10mV					40 Hz... 10 kHz	≤ 1 %	P01120405
		MN13		0.5 to 240 A				2 V AC				1A/10mV					40 Hz... 10 kHz	≤ 1 %	P01120406
		MN14		0.5 to 240 A				0.2 V AC				1A/1mV					40 Hz... 10 kHz	≤ 1 %	P01120416
		MN39	0.1 to 24 A 0.5 to 240 A				2 V AC 2 V AC					1A/100mV 1A/10mV					40 Hz... 10 kHz	≤ 1 %	P01120408
		MN73	10 mA to 2.4 A 100 mA to 240 A				2 V AC 2 V AC					1mA/1mV 1A/10mV					40 Hz... 10 kHz	≤ 1 % ≤ 2 %	P01120421
	MN89		0.5 to 240 A				20 V DC ⁽²⁾				1A/100mV					40 Hz... 10 kHz	≤ 2 %	P01120415	
	AC/DC		Y1N		4 A to 600 A			0.5 A AC				1,000/1					48 Hz... 1 kHz	≤ 3 %	P01120001A
C100				0.1 A to 1,200 A			1 A AC				1,000/1					30 Hz... 10 kHz	≤ 0.5 %	P01120301	
		C103		0.1 A to 1,200 A			1 A AC				1,000/1					30 Hz... 10 kHz	≤ 0.5 %	P01120303	
		C122		1 A to 1,200 A			5 A AC				1,000/5					30 Hz... 10 kHz	≤ 1 %	P01120306	
		C148		1 to 300 A 1 to 600 A 1 to 1,200 A			5 A AC					250/5 500/5 1,000/5					48 Hz... 1 kHz	≤ 2 % ≤ 1 % ≤ 1 %	P01120307
			C173	1 mA to 1.2 A 0.01 to 12 A 0.1 to 120 A 1 to 1,200 A			1 V AC					1A/1V 10A/1V 100A/1V 1,000A/1V					10 Hz... 3 kHz	≤ 0.7 % ≤ 0.5 % ≤ 0.3 % ≤ 0.2 %	P01120309
			D30CN		1 to 3,600 A			1 A AC				3,000/1					30 Hz... 5 kHz	≤ 0.5 %	P01120064
D36N				1 to 3,600 A			3 A AC				3,000/3					30 Hz... 5 kHz	≤ 0.5 %	P01120055A	
AC/DC			K1	1 mA to 4.5 A DC 1 mA to 3 A RMS 1 mA to 4.5 A peak				4.5 V DC 3 V RMS 4.5 V peak				1mA/1mV					DC... 2 kHz	≤ 1 %	P01120067
			K2	100 µA to 450 mA DC 100 µA to 300 mA RMS 100 µA to 450 A peak				4.5 V DC 3 V RMS 4.5 V peak				1mA/10mV					DC... 1.5 kHz	≤ 1 %	P01120074
		E1N	0.05 to 2 A DC 0.05 to 1.5 A AC 0.5 to 150 A AC/DC				2 V DC 1.5 V AC 150 mV AC/DC				1A/1V 1A/1mV					DC... 2 kHz DC... 8 kHz	≤ 2 % ≤ 1.5 %	P01120030A	
		E6N	5 mA to 2 A DC 5 mA to 1.5 A AC 20 mA to 80 A AC/DC				2 V AC 1.5 V AC 0.8 V AC/DC				1A/1V 1A/10mV					DC... 2 kHz DC... 8 kHz	≤ 2 % ≤ 4 %	P01120040A	

(1) the higher value corresponds to 120% of the max. rated value

(2) Reshaping of AC signal by diodes

(3) Lead + electronic unit with Ø 4 mm safety plugs, 19 mm spacing, for K series

AC/DC current measurement



Series	Model	Input ⁽¹⁾						Output / Connections				Specific features				To order	
		Very low current	Low current	Medium current	High current	~ AC	DC	Current	Voltage	Leads + safety plug ø 4 mm ⁽²⁾	Female sockets ø 4 mm	BNC connector (oscilloscope)	Transformation ratio (input/output)	Output protected against overvoltage	Automatic DC zero		Bandwidth (frequency in Hz)
	PAC10	0.5 to 400 A AC 0.5 to 600 A DC						600 mV AC/DC				1A/1mV			DC... 5 kHz	≤ 2%	P01120070
	PAC11	0.2 to 40 A AC 0.4 to 60 A AC 0.5 to 400 A AC 0.5 to 600 A DC						600 mV AC/DC				1A/10mV 1A/1mV			DC... 10 kHz	≤ 1.5% ≤ 2%	P01120068
	PAC20	0.5 to 1,000 A AC 0.5 to 1,400 A DC						1.4 V AC/DC				1A/1mV			DC... 5 kHz	≤ 2%	P01120071
	PAC21	0.2 to 100 A AC 0.4 to 150 A DC 0.5 to 1,000 A AC 0.5 to 1,400 A DC						1.4 V AC/DC				1A/10mV 1A/1mV			DC... 10 kHz	≤ 1.5% ≤ 2.5%	P01120069

(1) The higher value corresponds to 120% of the max. rated value (2) Lead + electronic housing with Ø 4 mm safety plugs, centre distance 19 mm, for K series.

Measurement on oscilloscope

Series	Model	Input						Output / Connections				Specific features				To order			
		Measurement range ⁽¹⁾						Current	Voltage	Lead + ø4 mm safety plugs ⁽²⁾	Female sockets ø 4 mm	BNC connector (coaxial)	Transformation ratio (input/output)	Output protected against overvoltages	Automatic DC zero		Power measurement (low phase shift)	Bandwidth (frequency in Hz)	Typical accuracy
AC	MN60	0.1 A to 60 A peak 0.5 A to 600 A peak						6 V peak				1 A / 100 mV 1 A / 10 mV					40Hz to 40kHz	≤ 2% ≤ 1.5%	P01120409
	Y7N	1 A to 1.200 A peak						1.2 V peak				1 mA / 1 mV					5Hz to 10kHz	≤ 2%	P01120075
	C160	0.1 A to 30 A peak 1 A to 300 A peak 1 A to 2.000 A peak						3 V peak 3 V peak 2 V peak				10 A/1 V 100 A/1 V 1.000 A/1 V					10Hz to 100kHz	≤ 3% ≤ 2% ≤ 1%	P01120308
	D38N	1 A to 90 A peak 1 A to 900 A peak 1 A to 9,000 A peak						0.9 V peak				1 A/10 V 1 A/1mV 1 A/0.1mV					30Hz to 50kHz	≤ 2%	P01120057A
	MA 200	MA200 30-300/3 (17 cm) MA200 30-300/3 (25 cm) MA200 3000 /3 (35 cm)	0.5 A...45 A peak 0.5 A...450 A peak 0.5 A...45 A peak 0.5 A...450 A peak 5 A...4,500 A peak						4.5 V peak 4.5 V peak 4.5 V peak				100 mV/A 10 mV/A 100 mV/A 10 mV/A 1 mV/A					5 Hz... 1MHz phase shift at 1kHz ≤ 1.5 5 Hz... 1MHz phase shift at 1kHz ≤ 1.5 5 Hz... 1MHz phase shift at 1kHz ≤ 1.5	≤ 1% ≤ 1% ≤ 1% + 0.3 A + 0.3 A
AC/DC	E3N	0.05 A to 10 A peak 1 A to 100 A peak						1 V peak				1 A / 10 mV 1 A / 1 mV					DC to 100kHz	≤ 3% ≤ 4%	P01120043A
	PAC12	0.2 A to 60 A peak 0.4 A to 60 A DC 0.5 A to 600 A peak 0.5 A to 600 A DC						600 mV peak				1 A / 10 mV 1 A / 1 mV					DC to 10kHz	≤ 1.5% ≤ 2%	P01120072
	PAC22	0.2 A to 150 A peak 0.4 A to 150 A DC 0.5 A to 1.400 A peak 0.5 A to 1.400 A DC						1.4 peak				1 A / 10 mV 1 A / 1 mV					DC to 10kHz	≤ 1.5% ≤ 2.5%	P01120073

(1) The higher value corresponds to 120% of the max. rated value (2) Lead + electronic unit with Ø 4 mm safety plugs with 19 mm spacing for the AmpFLEX series

Current measurement

AC current measurement

TRMS digital ammeters
with flexible sensors

DigiFlex



	MA400D			MA4000D		
	4 A AC	40 A AC	400 A AC	40 A AC	400 A AC	4,000 A AC
Display range	4 A AC	40 A AC	400 A AC	40 A AC	400 A AC	4,000 A AC
Measurement range	0.020 A... 3.999 A	4.00 A... 39.99 A	40.0 A... 399.9 A	0.01 A... 39.99 A	40.0 A... 399.9 A	400 A... 3,999 A
Resolution	1 mA	10 mA	100 mA	10 mA	100 mA	1 A
Accuracy	± (2 % + 10 cts)	± (1.5 % + 2 cts)	± (1.5 % + 2 cts)	± (2 % + 10 cts)	± (1.5 % + 2 cts)	± (1.5 % + 2 cts)
Sensor clamping diam. / length	MA400D-170: Ø 45 mm / 170 mm MA400D-250: Ø 70 mm / 250 mm			MA4000D-350: Ø 100 mm / 350 mm		
Bandwidth	10 Hz ... 3 kHz					
Power supply	2 x 1.5 V AAA/LR3 batteries					
Safety	IEC 61010 CAT IV 600V					
Operating temperature	0°C to +50°C					
Instrument weight	Approx. 130 g					
Casing dimensions	100 x 60 x 20 mm					
Length of connection cable	0.8 m					

State at Delivery

1 DigiFLEX sensor delivered in a blister pack with 2 x 1.5V AAA batteries, 1 elastic strap and an operating manual in 5 languages

To order

MA400D-170 > **P01120575Z**
 MA400D-250 > **P01120576Z**
 MA4000D-350 > **P01120577Z**

Accessories & Replacement Parts

Bag 120x200x60 > **P01298074**
 MULTIFIX accessories > **P01102100Z**
 Elastic strap > **P01102113**

Flexible current sensors

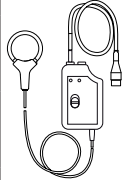
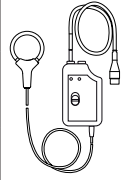
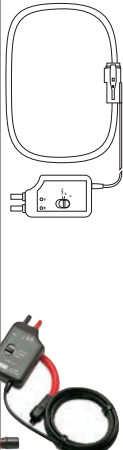
Series	Model	Input						Output / Connections				Specific features					To order	
		Meetgebied ⁽¹⁾						Current	Voltage	Lead + Ø4 mm safety plugs ⁽²⁾	Female sockets ø 4 mm	BNC connector (coaxial)	Transformation ratio (input/output)	Output protected against overvoltages	Automatic DC zero	Power measurement (low phase shift)		Bandwidth (frequency in Hz)
Very low current	Low current	Medium current	High current	AC	DC													
	MA100 30-300/3 (17 cm)	0.5 A...30 A	0.5 A...300 A					3 V AC	●			100 mV/A 10 mV/A				5 Hz... 20kHz phase shift at 1kHz ≤ 1.5°	≤ 1%	P01120560
	MA100 30-300/3 (17 cm)	0.5 A...30 A	0.5 A...300 A					3 V AC		●		100 mV/A 10 mV/A					≤ 1%	P01120563
	MA100 300-3000/3 (25 cm)	0.5 A...300 A	0.5 A...3,000 A					3 V AC	●			10 mV/A 1 mV/A					≤ 1%	P01120561
	MA100 300-3000/3 (25 cm)	0.5 A...300 A	0.5 A...3,000 A					3 V AC		●		10 mV/A 1 mV/A					≤ 1%	P01120564
	MA100 300-3000/3 (35 cm)	0.5 A...300 A	0.5 A...3,000 A					3 V AC	●			10 mV/A 1 mV/A					≤ 1%	P01120562
	MA100 300-3000/3 (35 cm)	0.5 A...300 A	0.5 A...3,000 A					3 V AC		●		10 mV/A 1 mV/A					≤ 1%	P01120565
	MA200 30-300/3 (17 cm)	0.5 A...45 A peak	0.5 A...450 A peak					4.5 V peak		●		100 mV/A 10 mV/A			5 Hz... 1MHz phase shift at 1kHz ≤ 1.5°	≤ 1% + 0.3 A	P01120570	
	MA200 30-300/3 (25 cm)	0.5 A...45 A peak	0.5 A...450 A peak					4.5 V peak		●		100 mV/A 10 mV/A				≤ 1% + 0.3 A	P01120571	
	MA200 3000/3 (35 cm)	5 A...4,500 A peak						4.5 V peak		●		1 mV/A				≤ 1% + 0.3 A	P01120572	
	A100 20-200/2 (45 cm)	0.5 A...20 A	0.5 A...200 A					2 V AC	●			1 A / 100 mV 1 A / 10 mV			10 kHz...20 kHz	≤ 1%	P01120503	
	A100 2000/2 (45 cm)	0.5 A...2,000 A						2 V AC	●			1 A / 1 mV				≤ 1%	P01120501	
	A100 2000/2 (80 cm)	0.5 A...2,000 A						2 V AC	●			1 A / 1 mV				≤ 1%	P01120502	
	A100 0.2-2 k/2 (45 cm)	0.5 A...200 A	0.5 A...2,000 A					2 V AC	●			1 A / 10 mV 1 A / 1 mV				≤ 1%	P01120504	
	A100 0.2-2 k/2 (80 cm)	0.5 A...200 A	0.5 A...2,000 A					2 V AC	●			1 A / 10 mV 1 A / 1 mV				≤ 1%	P01120505	
	A100 0.3-3 k/3 (45 cm)	0.5 A...300 A	0.5 A...3,000 A					3 V AC	●			1 A / 10 mV 1 A / 1 mV				≤ 1%	P01120506	
	A100 0.3-3 k/3 (80 cm)	0.5 A...300 A	0.5 A...3,000 A					3 V AC	●			1 A / 10 mV 1 A / 1 mV				≤ 1%	P01120507	
	A100 0.3-3 k/3 (120 cm)	0.5 A...300 A	0.5 A...3,000 A					3 V AC	●			1 A / 10 mV 1 A / 1 mV				≤ 1%	P01120508	
	A100 1-10 k/1 (120 cm)	0.5 A...1,000 A	0.5 A...10,000 A					1 V AC	●			1 A / 1 mV 1 A / 0.1 mV				≤ 1%	P01120509	

(1) The higher value corresponds to 120 % of the max. rated value
(2) Lead + electronic unit with Ø 4 mm safety plugs with 19 mm spacing

- **MiniFlex® MA100:** the MA100 sensors are equipped with two types of outputs: via isolated Ø 4 mm banana plugs with 19 mm spacing or via BNC.
- **MiniFlex® MA200:** the MA200 isolated current sensors are equipped with a BNC output. They offer high bandwidth and are ideal for viewing transient signals.
- **AmpFlex® A100:** the range comprises 9 standard models dedicated to measuring alternating currents from 0.5 to 10 kA at industrial frequencies. Each flexible coil is connected by a screened cable to a small box containing the processing electronics and a standard 9 V battery. The spacing of the sockets (19 mm) facilitates direct connection to any type of multimeter, tester or recorder equipped with an AC voltage input (impedance Z > 1MΩ).









Accessories

For unlimited operation of your AmpFlex®: replace the battery with a mains adapter.





- Adapter for AmpFlex® > **P01101968**
- Adapter for MA100 > **P01102086**
- Adapter for MA200 > **P01102087**

Test and Measurement Accessories

Banana connection accessories, Ø 4 mm

Moulded leads				
Model	Description	Specifications		Reference
	Set of 2 red/black moulded PVC leads	Straight isolated male plug Ø 4 mm – Straight isolated male plug Ø 4 mm	<ul style="list-style-type: none"> • 15 A • 1.5 m • 1,000 V CAT IV 	P01295450Z
	Set of 2 red/black moulded PVC leads	Straight isolated male plug Ø 4 mm – Elbowed isolated male plug Ø 4 mm	<ul style="list-style-type: none"> • 15 A • 1.5 m • 1,000 V CAT IV 	P01295451Z
	Set of 2 red/black moulded Silicone leads	Straight isolated male plug Ø 4 mm – Straight isolated male plug Ø 4 mm	<ul style="list-style-type: none"> • 15 A • 1.5 m • 1,000 V CAT IV 	P01295452Z
	Set of 2 red/black moulded Silicone leads	Straight isolated male plug Ø 4 mm – Elbowed isolated male plug Ø 4 mm	<ul style="list-style-type: none"> • 15 A • 1.5 m • 1,000 V CAT IV 	P01295453Z
Standard leads				
	Set of 2 red/black PVC leads	Straight isolated male plug Ø 4 mm – Straight isolated male plug Ø 4 mm	<ul style="list-style-type: none"> • 15 A • 1.5 m • 600 V CAT IV / 1,000 V CAT III 	P01295288Z
	Set of 2 red/black PVC leads	Straight isolated male plug Ø 4 mm – Elbowed isolated male plug Ø 4 mm	<ul style="list-style-type: none"> • 15 A • 1.5 m • 600 V CAT IV / 1,000 V CAT III 	P01295289Z
	Set of 2 red/black PVC leads	Straight isolated male plug Ø 4 mm with rear connection – Straight isolated male plug Ø 4 mm with rear connection	<ul style="list-style-type: none"> • 20 A • 2 m • 600 V CAT III 	P01295290Z
Leads with built-in test probes				
	Set of 2 red/black PVC test-probe leads	Straight isolated male plug Ø 4 mm	<ul style="list-style-type: none"> • 15 A • 1.5 m • 1,000 V CAT IV 	P01295455Z
	Set of 2 red/black PVC test-probe leads	Elbowed isolated male plug Ø 4 mm	<ul style="list-style-type: none"> • 15 A • 1.5 m • 1,000 V CAT IV 	P01295456Z

Banana connection accessories, Ø 4 mm

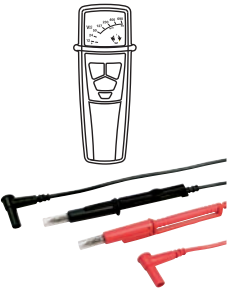
For CAT IV and CAT III installations				
Model	Description	Specifications		Reference
	Set of 2 red/black moulded test probes	Female plug Ø 4 mm	• CAT IV / CAT III 1,000 V	P01295454Z
For CAT II installation and below				
	Set of 2 moulded test probes Ø 4 mm	Female plug Ø 4 mm	• CAT II 300 V	P01295458Z
	Set of 2 moulded test probes Ø 2 mm	Female plug Ø 4 mm	• CAT II 300 V	P01295460Z
IP2X				
	Set of 2 IP2X PVC leads for digital multimeters	Complies with NF C 18-510 and IEC 61010-031+A1:2008 IP2X test probe Elbowed isolated male plug	• 15 A • 1.5 m • 600 V CAT IV	P01295461Z
	Set of 2 IP2X PVC leads for voltage detectors	Complies with NF.C.18-510 and IEC 61010-031+A1:2008 IP2X test probe Ø 2 mm Elbowed female plug Ø 4 mm	• 15 A • 1.5 m • 600 V CAT IV	P01295463Z
For 	Set of 2 IP2X leads for voltage detectors for C.A 740N and C.A 760N	IP2X test probe Ø 4 mm Elbowed female plug Ø 4 mm	• 15 A • NF C 18-510 / IEC 61243-3 1,000 V	• 1.5 m: P01295462Z • 0.25 m & 0.85 m: P01295285Z

Test and Measurement Accessories

Protection and transport accessories



Product	Reference	Description
C.A 6416 / C.A 6417	P01298080	Hard Case
C.A 740N / C.A 760N / C.A 740N IP2X / C.A 760N IP2X	P01298074	Bag
C.A 1510	P01298071	Hard Case
F200	P01298075	Bag
F400 / F600	P01298043Z	Bag
MTX 3281/3282/3283	P01298076	Bag
MX 57Ex	AE0193	Soft carrying case
	AE0227	Hard Case
MX 22 / MX 24B	AE0190	Soft carrying case
MX 22 / MX 24B	HX0009	Hard Case
K clamp	P01298039	Soft carrying case
Standard		
	P01298071	Soft carrying case 270 x 195 x 65 mm
	P01298004	Soft carrying case 320 x 255 x 75 mm
	P01298072	Soft carrying case 440 x 310 x 135 mm
	P01298068	On-site case 272 x 248 x 130 mm
	P01298069	On-site case 272 x 248 x 182 mm

... by function

A					
Accessories:					
• Ø 4 mm banana connectors		p.36/37			
• transport accessories (soft cases, hard cases, bags)		p.38			
• protective accessories (soft cases, hard cases, bags)		p.38			
• Essailec		p.27			
AmpFlex® TM A100		p.35			
AmpFlex® clamps		p.27			
ASYC IV digital multimeter		p.13			
ATEX multimeter		p.12			
AVG digital multimeter		p.12			
AVG multimeter for difficult environments		p.12			
C					
Clamps:					
• AC current clamps		p.27/33/34			
• AC/DC current clamps		p.27/33/34			
• digital multimeter clamps		p.08/09			
• earth clamps and loop testers		p.23			
D					
DataView software		p.19/27			
			Digital insulation testers		p.19/20
			E		
			Earth and resistivity kit		p.21
			Earth and resistivity testers and adapter for pylon earth measurements		p.22
			Earth and resistivity testers		p.21
			Electrical energy analysers for three-phase networks		p.26/27/28
			Flexible current sensors		p.33/34/35
			G		
			Gas detector		p.31
			I		
			Installation testers		p.17
			L		
			Light meters		p.30
			Locate hidden cables		p.23
			M		
			Megohmmeters (see Installation Testers)		
			Micro-ohmmeters		p.24
			Mini AC current clamps		p.32
			N		
			Non-contact thermometers		p.30
			O		
			On-site digital oscilloscopes		p.15
			Oscilloscopes with isolated channels		p.14
			P		
			Power Analyser transfer software		p.27
			Power and energy loggers		p.29
			R		
			Single-phase ratiometer		p.24
			T		
			Tachometers		p.30
			TRMS digital multimeter		p.12
			TRMS graphical digital multimeters		p.13
			TRMS multimeters for difficult environments		p.12
			TRMS multimeters		p.11
			Two-pole voltage absence testers		p.10

.... by product

A					
A196-450/A193-450/A193-800	AmpFlex® clamps		p.27		
AmpFlex® A100	flexible current sensors		p.35		
C					
C100 to C173	AC current clamps		p.32/33		
C193	AC current clamp		p.27		
C.A 740N/760N	two-pole voltage absence testers		p.10		
C.A 811/813	light meters		p.30		
C.A 871/879	non-contact thermometers		p.30		
C.A 1510/1510W	gas detector		p.31		
C.A 1725/1727	tachometers		p.30		
C.A 1864/1866	non-contact thermometers		p.30		
C.A 5271/5273/5275/5277	TRMS multimeters		p.11		
C.A 6116N/6117	installation testers		p.17		
C.A 6240/6250	micro-ohmmeters		p.24		
C.A 6416/6417	earth clamps and loop testers		p.23		
C.A 6460/6462/6470N/6471	earth and resistivity testers		p.21		
C.A 6472/6474	earth and resistivity testers with adapter for pylon earth measurements		p.22		
C.A 6505	digital insulation tester		p.19		
C.A 6523/6525	digital insulation testers		p.18		
C.A 6541/6543/6545/6547/6549	digital insulation testers		p.19		
C.A 6550/6555	digital insulation testers		p.20		
C.A 6681	locate hidden cables		p.23		
C.A 8220/ 8230	electrical energy analysers for three-phase networks		p.28		
C.A 8331/8333/8336/8435	electrical energy analysers for three-phase networks		p.26/27		
D					
D30CN / D36N	AC current clamps		p.32		
D38N AC	current clamp		p.33		
DataView®	software		p.19/27		
DTR 8510	single-phase ratiometer		p.24		
E					
E1N / E6N	AC / DC current clamps		p.32		
E3N	AC / DC current clamps		p.27/33		
Earth and resistivity kit			p.21		
Essailec			p.27		
				F	
				F201/203/205	digital multimeter clamps p.08/09
				F401/403/405/F407	digital multimeter clamps p.08/09
				F601/603/605/F607	digital multimeter clamps p.08/09
			K		
			K1/ K2	AC / DC current clamps	p.32
			M		
			MA 100	flexible current sensors	p.35
			MA 200	flexible current sensors	p.33/35
			MA193	AC current clamp	p.27
			MA400D/MA4000D	flexible current sensors	p.34
			MINI 01/02/03/05/09	mini AC current clamps	p.32
			MN 08 to MN 89	AC current clamps	p.32
			MN60	AC current clamp	p.33
			MN93/MN 93A	AC current clamps	p.27
			MTX 3290/3291/3292/3293	digital multimeters	p.13
			MX 57Ex	ATEX multimeter	p.12
			MX22 AVG	digital multimeter	p.12
			MX24B	TRMS digital multimeter	p.12
			O		
			Ø 4 mm banana connection accessories		p. 36/37
			OX 5022/5042	on-site digital oscilloscopes	p.15
			OX 7042/7062	oscilloscopes with isolated channels	p.14
			OX 7102/7104/7202/7204	oscilloscopes with isolated channels	p.14
			P		
			PAC 10/11/12	AC/DC current clamps	p.33
			PAC 20/21/22	AC/DC current clamps	p.33
			PAC93	AC/DC current clamps	p.27
			PEL 102/103	power and energy loggers	p.29
			Power Analyser transfer software		p.27
			Protective accessories (soft cases, hard cases, bags)		p.38
			Transport accessories (soft cases, hard cases, bags)		p.38
			Y		
			Y1N	AC current clamp	p.32
			Y7N	AC current clamp	p.33



Chauvin Arnoux International

190, rue Championnet
75876 Paris Cedex 18 - FRANCE
export@chauvin-arnoux.fr
www.chauvin-arnoux.com
tel: +33 1 44 85 44 38
fax: +33 1 46 27 95 59